



## **WHEELED EXCAVATOR | JS200W**

Engine power: 129kW (172hp) Operating weight: 20475 - 23773kg Bucket capacity: 0.4 - 1.18m<sup>3</sup>





## STRENGTH INSIDE AND OUT.

BEFORE YOU BUY AN EXCAVATOR, YOU NEED TO KNOW IT'S GOING TO BE TOUGH ENOUGH TO PERFORM ANY JOB YOU ASK OF IT. FORTUNATELY, WITH A JCB JS200W, STRENGTH AND DURABILITY COME AS STANDARD.



1

### Boom and dipper.

1 A JS200W's reinforced boom and dipper is made of high tensile strength steel, with single piece wrapper plates and internal baffle plates for long life durability.

2 Our advanced manufacturing and assembly processes produce high precision and quality assembled components.

### Componentry.

3 Our engine technology is tried and proven; we've built 200,000 DIESELMAX units since 2004. To ensure similar longevity, the JS200W DIESELMAX T2 engine has been tested for 110,000 hours in 70 different machines across the toughest applications and environments.

4 JCB JS200W boasts the best components in the industry, that includes a JCB engine, ZF axles and Bosch Rexroth valve blocks and pumps. The JCB JS200W's selectable axle lock allows the operator to easily and conveniently adapt the machine to the task and terrain at hand.



2



3

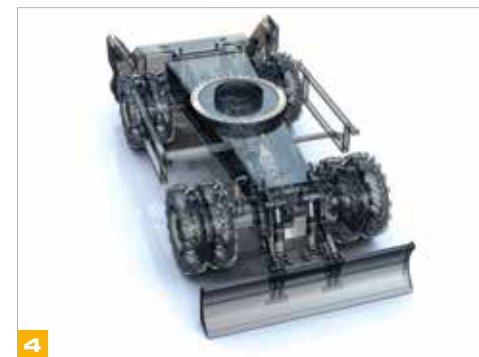

4



The JS200W is available with either a mono or two piece boom.

## Structural strength.

- 5** Our heavy-duty axles, dozers and stabilisers are designed for the toughest of applications. Available in a wide range of configurations, ensuring that it can be tailored to suit the job at hand.
- 6** A closed box section revolving frame increases strength and reduces stress. It's also highly resistant to impact damage.
- 7** The high-strength rigid upper frame provides maximum durability and support.
- 8** Our stiff, durable door design gives great strength and rigidity.



5



6



7



8



# MAXIMUM PRODUCTIVITY, MINIMUM SPEND.

IT'S MORE IMPORTANT THAN EVER TO SAVE MONEY AND TIME; THE NEW JCB JS200W WITH THE NEW DIESELMAX T2 ENGINES ARE DESIGNED TO WORK IN HARMONY TO DELIVER OUR MOST PRODUCTIVE AND EFFICIENT WHEELED EXCAVATOR.

## Versed in versatility.

**1** JCB's quickhitch system makes attachment changing fast and easy and is purpose-designed for the JS range which means the JS200W can adapt to a wide range of working applications just by adding a different JCB attachment. For ultra versatility, JCB offers a full list of auxiliary pipework options including hammer, auxiliary and low flow.



**2** The JS200W is equipped with an efficient and precise load sensed hydraulic system, designed for smooth multi-functional operation and maximum productivity.



**3** Every business is different, that's why the JS200W has a raft of options available to suit all of your business requirements. These options include chassis configurations, tyres, working attachments, hydraulic options, safety measures, additional hydraulic pumps, engine filtration systems and cooling options to name just a few.



Lifting, excavating, grading, unloading or with attachments, the JS200W is a multi-work tool designed to be more productive by being able to cover a wide range of tasks with ease and precision.





### Upping output.

4 To complement the smooth and consistent drive, the JS200W comes as standard with forward/neutral/reverse controls, conveniently located on the right hand joystick.

JCB's innovative hydraulic regeneration system means oil is recycled across the cylinders for faster cycle times and reduced fuel consumption. Advanced hydraulic technology, optimised hydraulic pump settings and enhanced design of electronic management software gives optimum fuel efficiency.

### The efficient excavator.

5 The new SMART Control electronics and Tier 2 JCB DIESELMAX engines benefit by working together to deliver a smooth high torque power band even at low engine speed up to the max of 2050rpm.

6 The JS200W's variable power bands allow you to tailor performance and therefore maximise efficiency. A new proportional control system for the engine cooling fan enables optimised fan speed, reducing noise pollution caused by unnecessary air flow, helping to reduce fuel consumption.

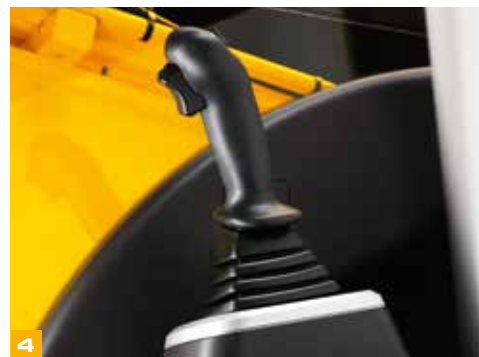

## A COMFORTABLE FAVOURITE.

WE'VE DESIGNED THE JCB JS200W TO BE VERSATILE, COMFORTABLE, ERGONOMIC AND INTUITIVE TO OPERATE. WHICH IS GOOD FOR YOUR OPERATORS BUT EVEN BETTER FOR YOU; AFTER ALL, GREAT EASE OF USE EQUALS GREAT PRODUCTIVITY.

### The working environment.

**1** The JS200W offers a quieter working environment inside and out. Because we've reduced noise levels to 73dB(A) internal and 100dB(A) you can use the machine in any location, any time.

The JCB JS200W cab uses 6 viscous rubber mounts to minimise noise and vibration.

**2** Light, intuitive and smooth controls improve comfort and productivity. Joystick mounted power boost button allows for quick access of extra hydraulic power.

Proportional auxiliary control options offer smooth, precise control, improved multi-functionality and further fuel savings.

**3** The robust steering column and controls are independently adjustable so that it's simple to find the perfect operating position.

Rearward visibility is excellent thanks to the very compact DIESELMAX T2 engine which is innovatively packaged under a low level bonnet.

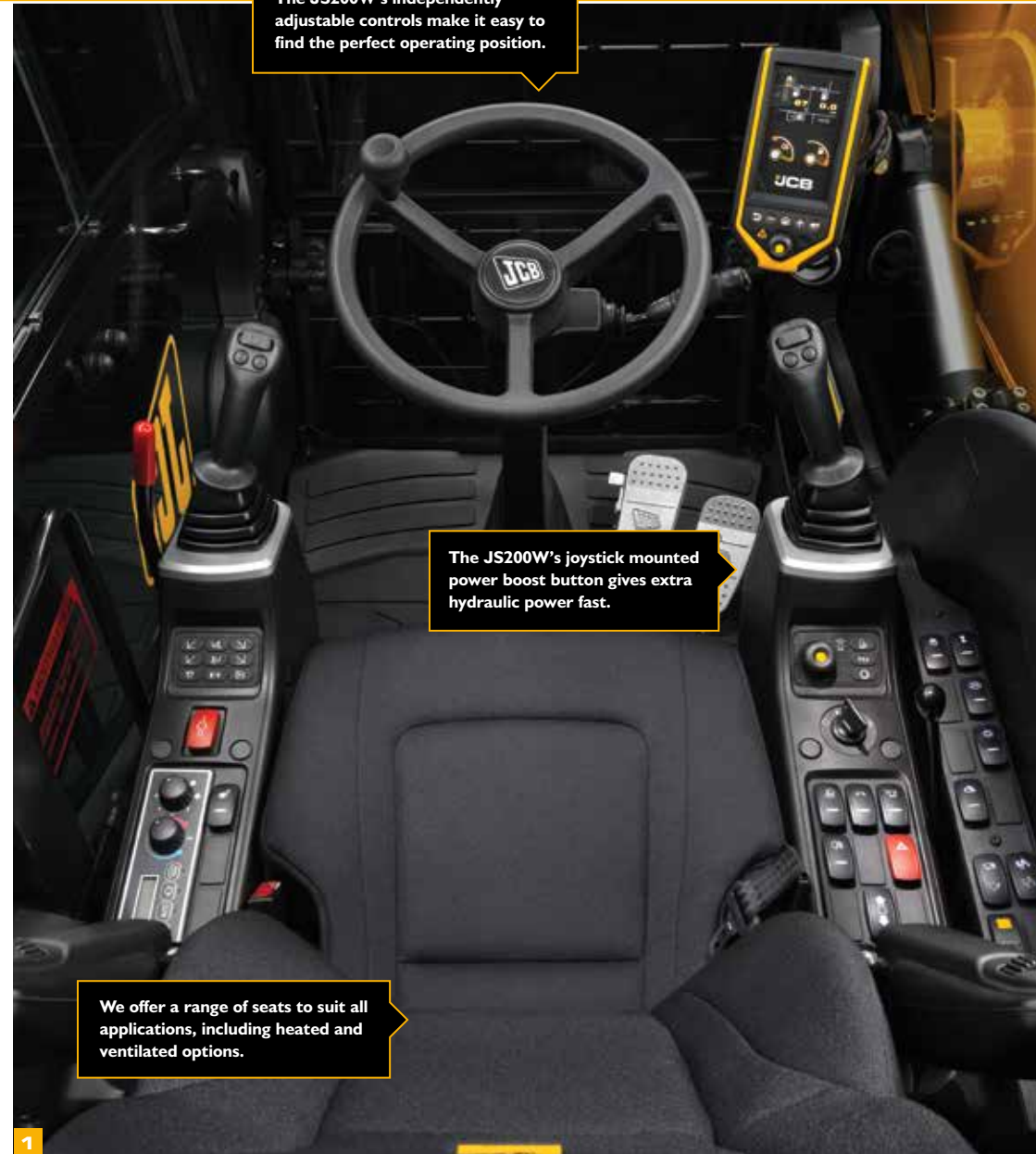

The JS200W's independently adjustable controls make it easy to find the perfect operating position.

The JS200W's joystick mounted power boost button gives extra hydraulic power fast.

We offer a range of seats to suit all applications, including heated and ventilated options.



A large laminated glass roof and window gives the JS200W optimum visibility when working at height. A balanced slew and electrohydraulic controlled slew braking give good speed and precision.



**Comfortably in control.**

- 4 JCB JS200W has a spacious luggage tray behind the operator's seat. With an auxiliary power socket, ideal for cool boxes.
- 5 JCB's climate control option offers a precisely controlled cab temperature with fresh or recirculated air. Demisting/defrosting functions keep the front window clear.
- 6 Work mode selection is done via the rotary throttle control, allowing the operator simple, quick and easy selection from one dial.
- 7 Conveniently located dozer and stabiliser controls coupled with smooth and responsive joysticks offer great control of the JS200W allowing for maximum productivity and ease of use.
- 8 The standard 7" full colour multi-function display is easy to read in all light conditions and provides instant access to information on the machine operation. With customisable home screens the operator can choose what information they want to see.



# LESS SERVICING, MORE SERVICE.

WE'VE DESIGNED THE JCB JS200W TO BE LOW MAINTENANCE AND EASILY SERVICEABLE. WHICH MAKES THEM AFFORDABLE, EFFICIENT AND HIGHLY PRODUCTIVE. HELPING YOU GET THE BEST SERVICE FROM YOUR MACHINE.



1

## Easy does it.

1 We've eliminated the need for a visibowl style pre-cleaner on the JS200W with our optional scavenger filtration system. This uses suction from the cooling fan to remove heavier particles from the induction system, helping to extend your air filter change intervals.

2 The filters on a JCB JS200W (engine oil, hydraulic oil and fuel) are centrally located for fast, easy servicing.

3 The easily located air filter makes removal and inspection simple. Because they're mounted side by side, the engine radiator, hydraulic cooler and intercooler can be serviced individually yet easily cleaned.

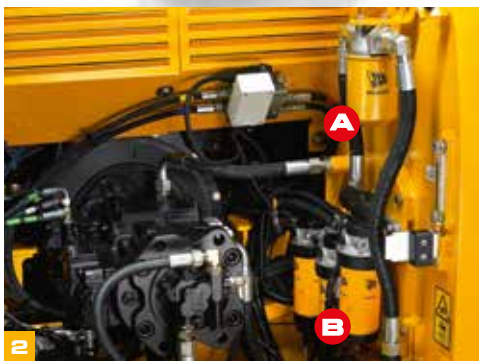

(A) Hydraulics oil filters (B) Fuel filters



SERVICE INTERVALS	
Engine oil and oil filter	Every <b>500</b> hours
Hydraulic oil	Every <b>5000</b> hours
Hydraulic oil filter	Every <b>1 000</b> hours



3





4

### Here to help.

4 The JCB JS200W as standard is fitted with a single point grease system which is conveniently located at ground level for ease of access and use.

5 Service your JCB JS175W with your local main dealer and our trained engineers can minimise downtime. Order genuine JCB parts online and, in 95% of cases, they'll be with you next day.

6 JCB JS200W bonnets open and close easily with gas-assisted cylinders, and the service bays are large and wide for good access.

7 JCB's NEW In-Cab Monitor checks engine oil levels and system errors on start-up.



5



6



7

## THE SAFE CHOICE.

ON-SITE SAFETY IS CRUCIAL, SO WE'VE DESIGNED THE JS200W TO INCORPORATE AS MANY CUTTING EDGE SAFEGUARDS AS POSSIBLE. IN SHORT, YOUR OPERATORS ARE IN SAFE HANDS.

### Safety as standard.

- 1 Steps and platforms have anti-slip punched steel plates for optimum grip, even in wet or icy conditions. Bolt-on plates have recessed bolts to reduce trip hazard.
- 2 An optional rear view camera can be fitted to further improve the field of vision.
- 3 JCB's 2GO system fully isolates hydraulic functions to avoid unintended movements. Our start function means a JCB JS200W can only be moved when in a safe condition via two separate inputs with the footbrake pressed.





**Visibly better.**

- 4 JCB JS200W has a large glass area and low bonnet line for superb all round visibility.
  - 5 The JCB JS200W is equipped with a full set of side and rear view mirrors for all-round visibility and safety compliance.
  - 6 Optional safety rails provide protection against falls from height for any operatives carrying out activities whilst on the upper structure of the vehicle.
  - 7 There's no need to climb onto the JS200W to check oil levels; all routine servicing can be done from ground level.
  - 8 Choose the LED work lights for an even better field of vision for the operator over standard work lights.
- Optional beacons can improve on-site safety still further.
- 9 For extra peace of mind, JCB JS200W cabs are available with an integral rollover protection structure (ROPS). It's easy to fit JCB's FOPS (Falling Objects Protection Structure) to a JS200W cab, thanks to standard fitment mounting brackets.



9



6



7



8

# LIVELINK, WORK SMARTER.

**LIVELINK IS AN INNOVATIVE SOFTWARE SYSTEM THAT LETS YOU MANAGE JCB MACHINES REMOTELY – ONLINE, BY EMAIL OR BY MOBILE PHONE. ACCESS EVERYTHING FROM MACHINE ALERTS TO FUEL REPORTS AND HISTORY INFORMATION, WITH ALL DATA STORED AT A SECURE CENTRE.**

## Productivity and cost benefits

By providing information like idle time monitoring and machine fuel consumption, JCB Livelink helps reduce your fuel usage, saving money and improving productivity. Machine location information can help improve efficiency and perhaps even reduce insurance costs.



## Maintenance benefits

Manage machine maintenance easily – accurate hours monitoring and service alerts improve maintenance planning, while real-time location data helps you manage your fleet. Critical machine alerts and maintenance history records are also available.



## Security benefits

Livelink's real-time geofencing alerts tell you when machines move out of predetermined zones, and real-time curfew alerts inform you of unauthorised usage. Further benefits include real-time location information, advanced ECU matching (pairs Livelink with the immobiliser or ECU).





## VALUE ADDED.

JCB'S WORLDWIDE CUSTOMER SUPPORT IS FIRST CLASS. WHATEVER YOU NEED AND WHEREVER YOU ARE, WE'LL BE AVAILABLE QUICKLY AND EFFICIENTLY TO HELP MAKE SURE YOUR MACHINERY IS PERFORMING TO ITS FULL POTENTIAL.



**1** Our Technical Support Service provides instant access to factory expertise, day or night, while our Finance and Insurance teams are always on hand to provide fast, flexible, competitive quotes.

**2** The global network of JCB Parts Centres is another model of efficiency; with 16 regional bases, we can deliver around 95% of all parts anywhere in the world within 24 hours. Our genuine JCB parts are designed to work in perfect harmony with your machine for optimum performance and productivity.



**3** JCB Assetcare offers comprehensive extended warranties and service agreements, as well as service-only or repair and maintenance contracts. Irrespective of what you opt for, our maintenance teams around the world charge competitive labour rates, and offer non-obligation quotations as well as fast, efficient insurance repair work.



*Note: JCB LIVELINK and JCB ASSETCARE may not be available in your region, so please check with your local dealer.*

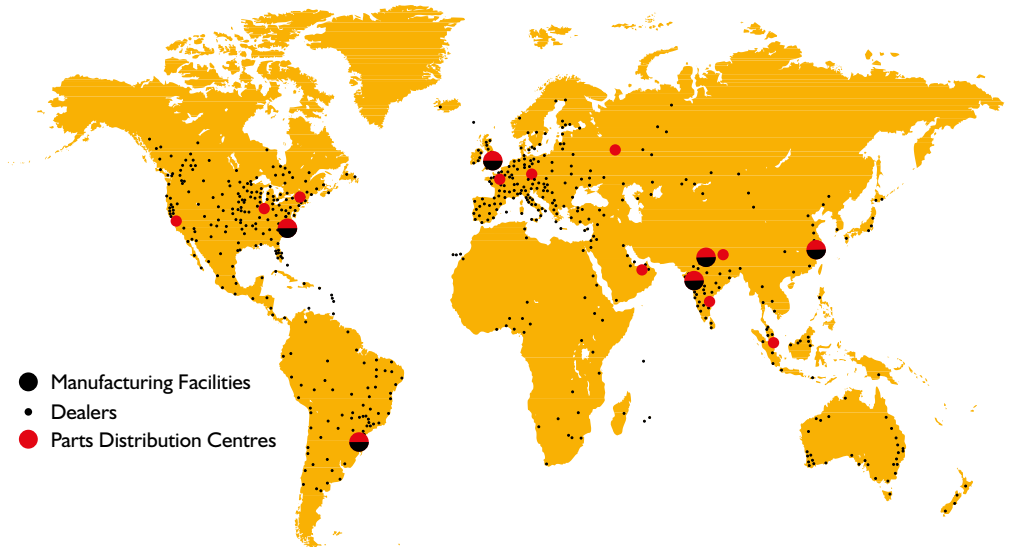

STATIC DIMENSIONS

MAX OPERATING WEIGHT: 23,773 kg ENGINE POWER: 129kW (172hp)

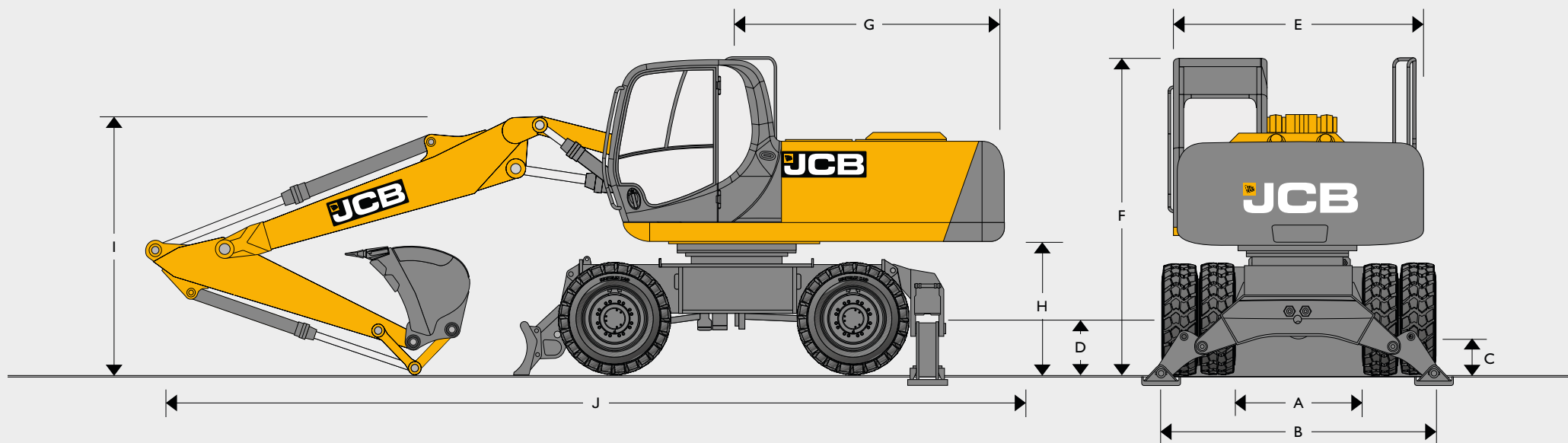

A	Internal width between dual wheels	mm	1330
B	External width over dual wheels - Standard/Wide	mm	2530/2750
C	Ground clearance	mm	260
D	Height to axle centre line dual wheels	mm	511
E	Overall width (handrail removed)	mm	2500
F	Height over cab	mm	3250
G	Tail length	mm	2530
H	Clearance under counterweight	mm	1335

Monoboam 5.70m

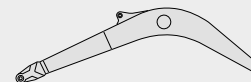

Dipper length			1.9m	2.4m	3m
I	Transport boom height	mm	3120	3200	3050
J	Transport length	mm	9450	9450	9330

Triple Articulated Boom 5.63m

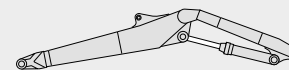

Dipper length			1.9m	2.4m	3m
I	Transport boom height	mm	3320	3400	3700
J	Transport length	mm	9175	9190	9200



CHASSIS OPTIONS

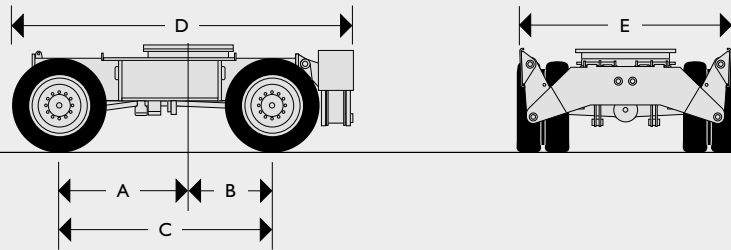

STABILISERS REAR

A	Centre of slew ring to front axle	mm	1507
B	Centre of slew ring to rear axle	mm	1250
C	Wheelbase	mm	2757
D	Length including rear stabilizers	mm	4350
E	Width over stabilizers (raised)	mm	2523

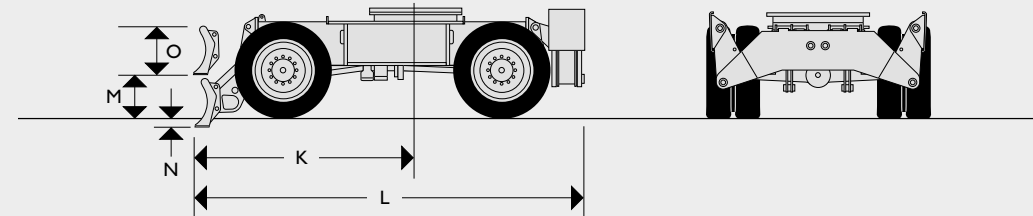

DOZER FRONT, STABILISER REAR

K	Centre of slew ring to front dozer blade (lowered)	mm	2760
L	Length including stabilizers and dozer blade (raised)	mm	5060
M	Ground level to bottom of front dozer blade (raised)	mm	450
N	Dozer blade dig depth	mm	130
O	Dozer blade height	mm	600

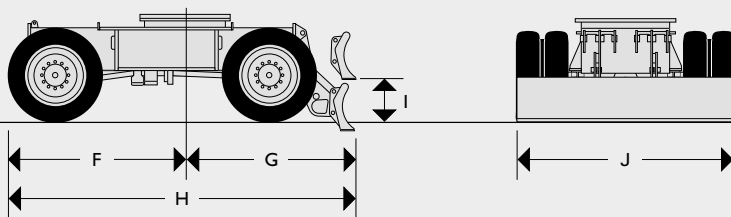

DOZER REAR

F	Centre of slew ring to face of front tyre	mm	2047
G	Centre of slew ring to rear dozer blade (lowered)	mm	2425
H	Length including rear dozer blade (raised)	mm	4470
I	Ground level to bottom of rear dozer blade (raised)	mm	450
J	Dozer blade width	mm	2530

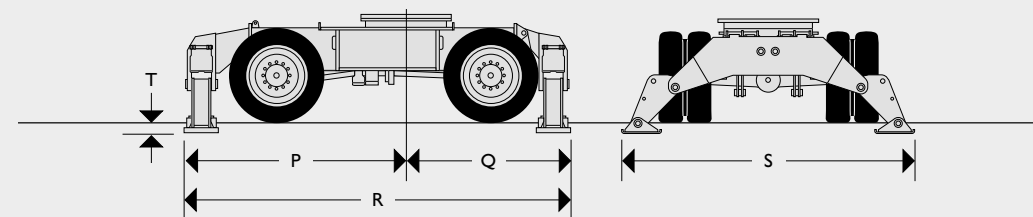

STABILISERS FRONT & REAR

P	Centre of slew ring to front stabilizers	mm	2632
Q	Centre of slew ring to rear stabilizers	mm	2300
R	Length including front and rear stabilizers	mm	4932
S	Width over stabilizers (lowered)	mm	3765
T	Stabilizer lift height	mm	201

ENGINE	
Model	JCB DIESELMAX 448, Tier 2 compliant.
Type	Water cooled, 4-stroke, 4-cylinder in-line, direct injection, turbocharged diesel.
Rated power (ISO 14396)	129kW (172hp).
Piston displacement	4.8 litres.
Injection	Electronic injection.
Air filtration	Dry element with secondary safety element and in cab warning indicator.
Cooling	Large capacity radiator.
Starting system	24 volt – 4kW.
Batteries	2 x 12 volt Heavy Duty.
Alternator	24 volt 55 amp.
Refuelling pump	Electric type.





SWING SYSTEM	
Drive train	Axial piston motor and planetary reduction final drive.
Swing brake	Hydraulic braking plus automatic spring applied disc type parking brake.
Swing speed	10 rpm
Swing gear	Large diameter, internally toothed fully sealed grease bath lubricated.
Swing lock	Multi-position switchable brake and mechanical lock.

CHASSIS		
Chassis options	2.5m ZF hub brake axles / 2.75 ZF hub brake axles (wide)	
Dozer blade	Front or rear pin mount.	
Stabilisers	Front or rear pin mount, independently operable – plus combinations.	
Grab stowage	Heavy duty, pin mounted stowage bar.	
Axles	Four wheel drive.	
Axle load capacity	40 tonnes.	
Axle oscillation	+/- 8.5 degrees.	
Ground clearance	335mm.	
Transmission	Hydrostatic drive via piston motor and powershift transmission.	
Travel speed	Creep speed	3kph (ZF)
	Low ratio	8kph (ZF)
	High ratio	30kph (ZF)
Drawbar pull	99.4 kN (ZF Axle)	
Steering	Fully hydraulic system.	
Turning radius	To outside of tyres	6.61m.
	To outer edge of front mounted dozer blade	7.23m.
Brakes	All hydraulic, dual circuit brake system.	
Parking brake	Built into the transmission.	
Gradeability	35° 70% max. continuous.	

TYRES		
Twins	Single	Flotation
11.00 x 20 tyres (16PR) with spacer ring	18R x 22.5 tyres (Radials)	600/40 x 22.5

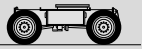
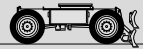
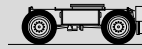
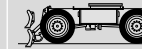
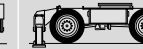
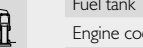

## OPERATING WEIGHTS

Chassis						
	20,475kg	21,283kg	21,380kg	22,647kg	23,202kg	23,202kg
	20,546kg	21,354kg	21,909kg	22,718kg	23,273kg	23,273kg
	21,046kg	21,854kg	22,409kg	23,218kg	23,773kg	23,773kg

Machine equipped with 2.7m dipper, excavating bucket and dual wheels. For single wheels subtract 400kg.

## STANDARD EXCAVATING BUCKETS

All buckets are JCB – Fully welded steel, with sealed, hardened steel pivot pins and replaceable wear parts.

Max Width mm	Capacity (SAE heaped) cu.m	Weight kg
600	0.40	484
900	0.71	595
1000	0.81	627
1200	1.03	705
1350	1.05	679
1450	1.14	720
1500	1.19	734

## SERVICE CAPACITIES

Fuel tank	litres	343
Engine coolant	litres	33.3
Engine oil	litres	24.5
Swing reduction gear	litres	5.0
Hydraulic system	litres	200
Hydraulic tank	litres	226
Transmission	litres	3.0
Axle hubs (each)	litres	2.5

## MAIN HYDRAULIC SYSTEM

<b>System</b>	Load-sensed hydraulic system with variable flow piston pump providing flow-on-demand for maximum efficiency.
<b>Main pumps</b>	Variable displacement axial piston type.
Maximum flow	1 x 424 l/min (93 UK gpm).
Main circuit pressure	343 bar.
With power boost	372 bar.
<b>Servo pump</b>	Gear type.
Maximum flow	31 l/min.
Servo pressure	40 bar.
<b>Optional circuits</b>	
<b>Hammer</b>	Includes automatic engine speed setting and return filter.
Maximum flow	200 l/min.
Maximum pressure	314 bar (pre-set to 180 bar).
<b>Low flow pipework</b>	Two options available, one with open centre and one closed. Both with flow adjustable from 20-45 l/min (4-10 UK gpm).
<b>Hydraulic cylinders</b>	With hardened, chromed piston rods and end cushioning on boom, dipper and bucket crowd cylinder.
<b>Filtration</b>	
In tank	150 micron, suction strainer.
Main return line	10 micron, fibreform element.
Pilot line	10 micron, paper element.
Hydraulic hammer return	10 micron, reinforced microform element.
<b>Cooling</b>	Worldwide cooling is provided by a single faced engine water, hydraulic oil and intercooler with swing forwards air conditioning condenser for easy cleaning.

WORKING RANGES

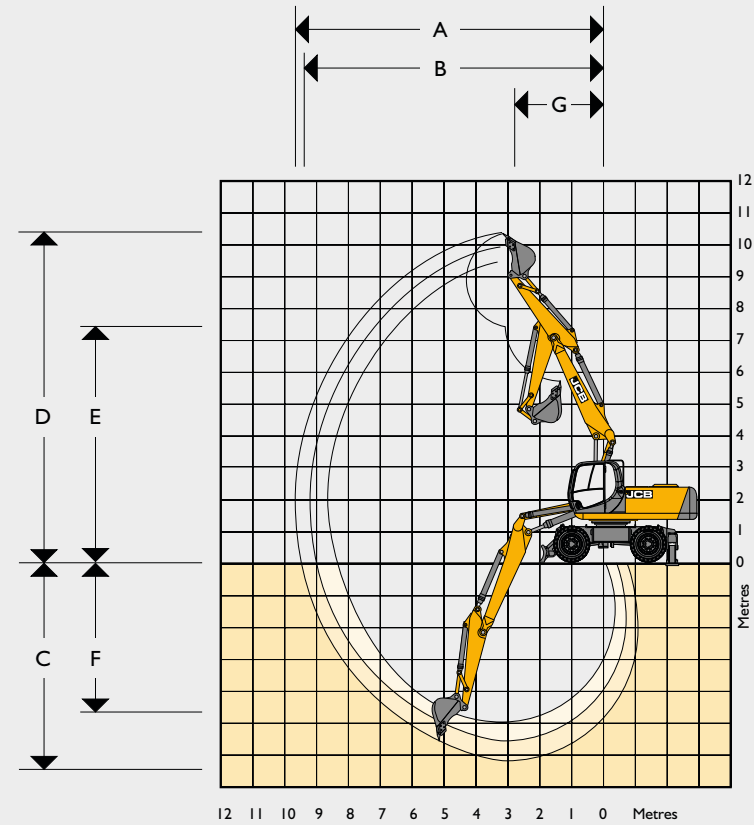
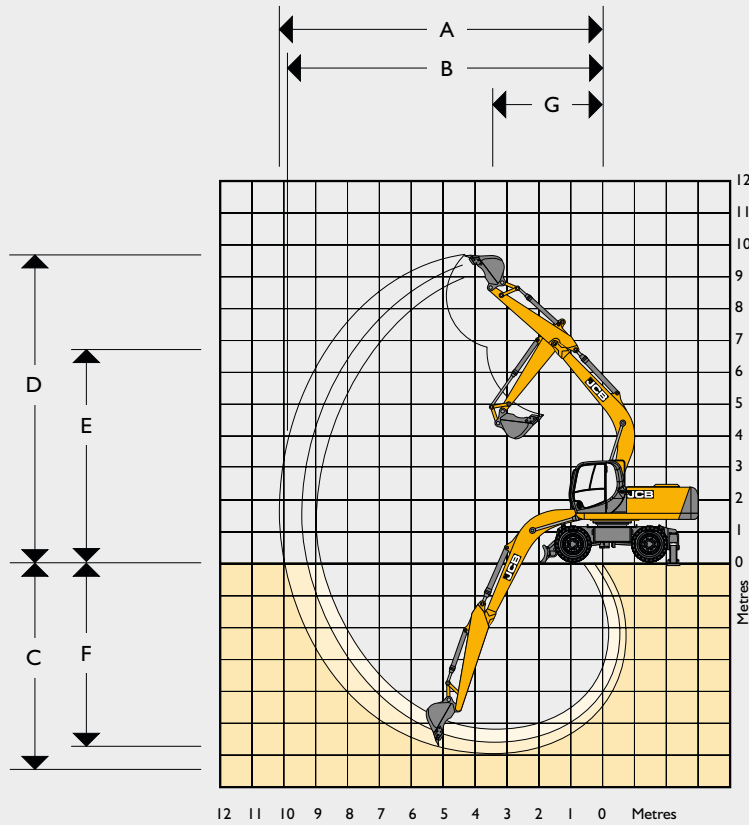

5.7m Monoboom

Dipper length		1.9m	2.4m	3m	
A	Max digging reach	mm	9110	9490	10,020
B	Max digging reach (on ground)	mm	8870	9310	9850
C	Max digging depth	mm	5260	5790	6370
D	Max digging height	mm	9190	9430	9630
E	Max loadover height	mm	6470	6760	6980
F	Max vertical wall cut depth	mm	4540	5240	5840
G	Min swing radius	mm	3900	3860	3750
	Bucket rotation		183°	183°	183°
	Dipper tearout	kgf	16,340	13,100	10,450
	Dipper tearout with boost	kgf	17,700	14,000	11,270
	Bucket tearout	kgf	11,770	11,770	11,770
	Bucket tearout with boost	kgf	12,710	12,710	12,710

5.63m T.A.B.

Dipper length		1.9m	2.4m	3m	
A	Max digging reach	mm	8860	9280	9825
B	Max digging reach (on ground)	mm	8650	9140	9650
C	Max digging depth	mm	5470	5960	6475
D	Max digging height	mm	9530	9930	10,160
E	Max loadover height	mm	6670	7060	7300
F	Max vertical wall cut depth	mm	3760	4200	4795
G	Min swing radius	mm	3250	3260	2905
	Bucket rotation		183°	183°	183°
	Dipper tearout	kgf	16,340	13,100	10,450
	Dipper tearout with boost	kgf	17,700	14,000	11,270
	Bucket tearout	kgf	11,770	11,770	11,770
	Bucket tearout with boost	kgf	12,710	12,710	12,710



**LIFT CAPACITIES – DIPPER LENGTH: 1.9M, MONOBOOM 5.1M, NO BUCKET, FRONT DOZER, REAR STABILISERS, 5 T COUNTERWEIGHT. JS200W MONO**

Reach	1.5m		3m		4.5m		6m		7.5m		Capacity at Max Reach			
														
Load Point Ht.	kg	kg	kg	kg	kg	kg	kg	kg	kg	kg	kg	kg	mm	
7.5m												6860*	6860*	5308
6m							6590*	6440				6450*	5540	6545
4.5m					8820*	8820*	7120*	6240				6340*	4600	7262
3m					10,910*	9090	7980*	5960	6780*	4280		6550*	4180	7613
1.5m					12,140*	8670	8710*	5720	7040*	4180		6930*	4060	7650
0m					12,220*	8570	9000*	5610				7160*	4230	7378
-1.5m			12,270*	12,270*	11,530*	8630	8630*	5620				7380*	4800	6758
-3m			12,920*	12,920*	9790*	8830						7430*	6290	5672
-4.5m														

**LIFT CAPACITIES – DIPPER LENGTH: 2.4M, MONOBOOM 5.1M, NO BUCKET, FRONT DOZER, REAR STABILISERS, 5 T COUNTERWEIGHT. JS200W MONO**

Reach	1.5m		3m		4.5m		6m		7.5m		Capacity at Max Reach			
														
Load Point Ht.	kg	kg	kg	kg	kg	kg	kg	kg	kg	kg	kg	kg	mm	
7.5m												5300*	5300*	5940
6m							6140*	6140*				4920*	4920*	7063
4.5m					8170*	8170*	6770*	6400	6210*	4500		4850*	4410	7731
3m					10,310*	9370	7710*	6100	6560*	4380		4990*	4050	8061
1.5m					11,880*	8850	8560*	5840	6960*	4260		5350*	3950	8096
0m					12,360*	8650	9020*	5680	7140*	4180		6040*	4080	7839
-1.5m			11,640*	11,640*	11,970*	8650	8900*	5650				7050*	4530	7260
-3m			14,560*	14,560*	10,630*	8800	7770*	5770				7230	5640	6266
-4.5m														

**LIFT CAPACITIES – DIPPER LENGTH: 3.0M, MONOBOOM 5.1M, NO BUCKET, FRONT DOZER, REAR STABILISERS, 5 T COUNTERWEIGHT. JS200W MONO**



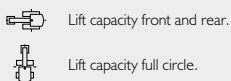



Reach	1.5m		3m		4.5m		6m		7.5m		Capacity at Max Reach			
														
Load Point Ht.	kg	kg	kg	kg	kg	kg	kg	kg	kg	kg	kg	kg	mm	
7.5m												3400*	3400*	6653
6m							5390*	5390*	3950*	3950*		3200*	3200*	7669
4.5m							6100*	6100*	5620*	4480		3160*	3160*	8287
3m					9300*	9300*	6100	7100*	6090*	4340		3260*	3260*	8594
1.5m					11,180*	8890	5800	8090*	6590*	4180		3490*	3390	8627
0m			6370*	6370*	12,090*	8570	5590	8740*	6930*	4070		3900*	3480	8388
-1.5m	7170*	7170*	10,860*	10,860*	12,090*	8490	5510	8880*	6880*	4040		4660*	3950	7850
-3m	11,690*	11,690*	16,000*	16,000*	11,190*	8570	5560	8270*				6220*	4720	6944
-4.5m			12,460*	12,460*	8870*	8860						6850*	6820	







**Notes:**

1. For lifting capacity including bucket, subtract total weight of bucket or bucket and quickhitch from above values.
2. Lifting capacities are based on ISO 10567, that is: 75% of minimum tipping load or 87% of hydraulic lift capacity, whichever is the less. Lifting capacities marked\* are based on hydraulic capacity.
3. Lift capacities assume that the machine is on firm, level ground.
4. Lift capacities may be limited by local regulations. Please refer to your dealer.

LIFT CAPACITIES – DIPPER LENGTH: 1.9M, MONOBOOM 5.1M, NO BUCKET, REAR STABILISERS, 5 T COUNTERWEIGHT.													JS200W MONO	
Reach	1.5m		3m		4.5m		6m		7.5m		Capacity at Max Reach			
														
Load Point Ht.	kg	kg	kg	kg	kg	kg	kg	kg	kg	kg	kg	kg	mm	
7.5m												6860*	6100	5308
6m							6590*	4970				6450*	4270	6545
4.5m					8820*	7380	7120*	4780				6240	3520	7262
3m					10,910*	6720	7980*	4510	5810	3250		5670	3180	7613
1.5m					12,140*	6330	8040	4290	5710	3160		5540	3070	7650
0m					12,220*	6240	7910	4180				5800	3190	7378
-1.5m			12,270*	12,270*	11,530*	6290	7920	4190				6640	3610	6758
-3m			12,920*	12,690*	9790*	6480						7430*	4720	5672
-4.5m														





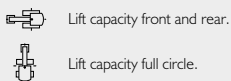

LIFT CAPACITIES – DIPPER LENGTH: 2.4M, MONOBOOM 5.1M, NO BUCKET, REAR STABILISERS, 5 T COUNTERWEIGHT.													JS200W MONO	
Reach	1.5m		3m		4.5m		6m		7.5m		Capacity at Max Reach			
														
Load Point Ht.	kg	kg	kg	kg	kg	kg	kg	kg	kg	kg	kg	kg	mm	
7.5m												5300*	5220	5940
6m							6140*	5140				4920*	3890	7063
4.5m					8170*	7640	6770*	4930	6050	3470		4850*	3290	7731
3m					10,310*	6980	7710*	4650	5920	3360		4990*	3000	8061
1.5m					11,880*	6500	8170	4400	5790	3240		5160	2900	8096
0m					12,360*	6320	7990	4260	5700	3160		5350	2990	7839
-1.5m			11,640*	11,640*	11,970*	6320	7950	4220				5990	3310	7260
-3m			14,560*	12,560	10,630*	6450	7770*	4340				7230*	4110	6266
-4.5m														

LIFT CAPACITIES – DIPPER LENGTH: 3.0M, MONOBOOM 5.1M, NO BUCKET, REAR STABILISERS, 5 T COUNTERWEIGHT.													JS200W MONO	
Reach	1.5m		3m		4.5m		6m		7.5m		Capacity at Max Reach			
														
Load Point Ht.	kg	kg	kg	kg	kg	kg	kg	kg	kg	kg	kg	kg	mm	
7.5m												3400*	3400*	6653
6m							5390*	5170	3950*	3520		3200*	3200*	7669
4.5m							6100*	4950	5620*	3450		3160*	2890	8287
3m					9300*	7100	7100*	4650	5890	3310		3260*	2640	8594
1.5m					11,180*	6530	8090*	4360	5720	3160		3490*	2560	8627
0m			6370*	6370*	12,090*	6230	7910	4170	5600	3060		3900*	2610	8388
-1.5m	7170*	7170*	10,860*	10,860*	12,090*	6160	7810	4090	5560	3020		4660*	2850	7850
-3m	11,690*	11,690*	16,000*	12,200	11,190*	6240	7860	4130				6220*	3420	6944
-4.5m			12,460*	12,460*	8870*	6490						6850*	4930	



- Notes:
1. For lifting capacity including bucket, subtract total weight of bucket or bucket and quickhitch from above values.
  2. Lifting capacities are based on ISO 10567, that is: 75% of minimum tipping load or 87% of hydraulic lift capacity, whichever is the less. Lifting capacities marked\* are based on hydraulic capacity.
  3. Lift capacities assume that the machine is on firm, level ground.
  4. Lift capacities may be limited by local regulations. Please refer to your dealer.



LIFT CAPACITIES – DIPPER LENGTH: 1.9M, MONOBOOM 5.1M, NO BUCKET, 4 STABILISERS, 5 T COUNTERWEIGHT.													JS200W MONO	
Reach	1.5m		3m		4.5m		6m		7.5m		Capacity at Max Reach			
														
Load Point Ht.	kg	kg	kg	kg	kg	kg	kg	kg	kg	kg	kg	kg	mm	
7.5m												6860*	6860*	5308
6m							6590*	6590*				6450*	6450*	6545
4.5m					8820*	8820*	7120*	7120*				6340*	5690	7262
3m					10,910*	10,910*	7980*	7460	6780*	5310		6550*	5190	7613
1.5m					12,140*	11,260	8710*	7210	7040*	5210		6930*	5060	7650
0m					12,220*	11,140	9000*	7090				7160*	5290	7378
-1.5m			12,270*	12,270*	11,530*	11,200	8630*	7100				7380*	6010	6758
-3m			12,920*	12,920*	9790*	9790*						7430*	7430*	5672
-4.5m														

LIFT CAPACITIES – DIPPER LENGTH: 2.4M, MONOBOOM 5.1M, NO BUCKET, 4 STABILISERS, 5 T COUNTERWEIGHT.													JS200W MONO	
Reach	1.5m		3m		4.5m		6m		7.5m		Capacity at Max Reach			
														
Load Point Ht.	kg	kg	kg	kg	kg	kg	kg	kg	kg	kg	kg	kg	mm	
7.5m												5300*	5300*	5940
6m							6140*	6140*				4920*	4920*	7063
4.5m					8170*	8170*	6770*	6770*	6210*	5540		4850*	4850*	7731
3m					10,310*	10,310*	7710*	7610	6560*	5420		4990*	4850	8061
1.5m					11,880*	11,450	8560*	7330	6960*	5290		5350*	4730	8096
0m					12,360*	11,230	9020*	7160	7140*	5210		6040*	4910	7839
-1.5m			11,640*	11,640*	11,970*	11,220	8900*	7130				7050*	5460	7260
-3m			14,560*	14,560*	10,630*	10,630*	7770*	7250				7230*	6830	6266
-4.5m														

LIFT CAPACITIES – DIPPER LENGTH: 3.0M, MONOBOOM 5.1M, NO BUCKET, 4 STABILISERS, 5 T COUNTERWEIGHT.													JS200W MONO	
Reach	1.5m		3m		4.5m		6m		7.5m		Capacity at Max Reach			
														
Load Point Ht.	kg	kg	kg	kg	kg	kg	kg	kg	kg	kg	kg	kg	mm	
7.5m												3400*	3400*	6653
6m							5390*	5390*	3950*	3950*		3200*	3200*	7669
4.5m							6100*	6100*	5620*	5530*		3160*	3160*	8287
3m					9300*	9300*	7100*	7100*	6090*	5380		3260*	3260*	8594
1.5m					11,180*	11,180*	8090*	7300	6590*	5220		3490*	3490*	8627
0m			6370*	6370*	12,090*	11,150	8740*	7080	6930*	5100		3900*	3900*	8388
-1.5m	7170*	7170*	10,860*	10,860*	12,090*	11,060	8880*	6990	6880*	5070		4660*	4660*	7850
-3m	11,690*	11,690*	16,000*	16,000*	11,190*	11,150	8270*	7040				6220*	5730	6944
-4.5m			12,460*	12,460*	8870*	8870*						6850*	6850*	5480

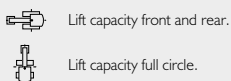

Notes:

1. For lifting capacity including bucket, subtract total weight of bucket or bucket and quickhitch from above values.
2. Lifting capacities are based on ISO 10567, that is: 75% of minimum tipping load or 87% of hydraulic lift capacity, whichever is the less. Lifting capacities marked\* are based on hydraulic capacity.
3. Lift capacities assume that the machine is on firm, level ground.
4. Lift capacities may be limited by local regulations. Please refer to your dealer.

LIFT CAPACITIES – DIPPER LENGTH: 1.9M, MONOBOOM 5.1M, NO BUCKET, REAR DOZER, 5 T COUNTERWEIGHT.													JS200W MONO	
Reach	1.5m		3m		4.5m		6m		7.5m		Capacity at Max Reach			
														
Load Point Ht.	kg	kg	kg	kg	kg	kg	kg	kg	kg	kg	kg	kg	mm	
7.5m												6860*	4880	5308
6m							6590*	3970				6450*	3390	6545
4.5m					8820*	5790	7120*	3790				6340*	2770	7262
3m					10,910*	5170	7980*	3530	6780*	2540		6550*	2480	7613
1.5m					12,140*	4810	8710*	3320	7040*	2450		6930*	2380	7650
0m					12,220*	4720	9000*	3210				7160*	2470	7378
-1.5m			12,270*	9080	11,530*	4770	8630*	3220				7380*	2790	6758
-3m			12,920*	9280	9790*	4950						7430*	3650	5672
-4.5m														

LIFT CAPACITIES – DIPPER LENGTH: 2.4M, MONOBOOM 5.1M, NO BUCKET, REAR DOZER, 5 T COUNTERWEIGHT.													JS200W MONO	
Reach	1.5m		3m		4.5m		6m		7.5m		Capacity at Max Reach			
														
Load Point Ht.	kg	kg	kg	kg	kg	kg	kg	kg	kg	kg	kg	kg	mm	
7.5m												5300*	4210	5940
6m							6140*	4140				4920*	3120	7063
4.5m					8170*	6060	6770*	3940	6210*	2760		4850*	2610	7731
3m					10,310*	5430	7710*	3680	6560*	2650		4990*	2360	8061
1.5m					11,880*	4990	8560*	3440	6960*	2540		5350*	2270	8096
0m					12,360*	4820	9020*	3300	7140*	2470		6040*	2330	7839
-1.5m			11,640*	8990	11,970*	4810	8900*	3270				7050*	2580	7260
-3m			14,560*	9210	10,630*	4940	7770*	3370				7230*	3210	6266
-4.5m														



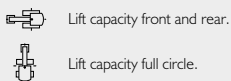









LIFT CAPACITIES – DIPPER LENGTH: 3.0M, MONOBOOM 5.1M, NO BUCKET, REAR DOZER, 5 T COUNTERWEIGHT.													JS200W MONO	
Reach	1.5m		3m		4.5m		6m		7.5m		Capacity at Max Reach			
														
Load Point Ht.	kg	kg	kg	kg	kg	kg	kg	kg	kg	kg	kg	kg	mm	
7.5m												3400*	3400*	6653
6m							5390*	4160	3950*	2790		3200*	2670	7669
4.5m							6100*	3940	5620*	2720		3160*	2260	8287
3m					9300*	5530	7100*	3650	6090*	2590		3260*	2050	8594
1.5m					11,180*	4980	8090*	3380	6590*	2450		3490*	1970	8627
0m			6370*	6370*	12,090*	4710	8740*	3200	6930*	2350		3900*	2000	8388
-1.5m	7170*	7170*	10,860*	8640	12,090*	4640	8880*	3120	6880*	2320		4660*	2190	7850
-3m	11,690*	11,690*	16,000*	8840	11,190*	4710	8270*	3160				6220*	2630	6944
-4.5m			12,460*	9240	8870*	4950						6850*	3810	













- Notes:
1. For lifting capacity including bucket, subtract total weight of bucket or bucket and quickhitch from above values.
  2. Lifting capacities are based on ISO 10567, that is: 75% of minimum tipping load or 87% of hydraulic lift capacity, whichever is the less. Lifting capacities marked\* are based on hydraulic capacity.
  3. Lift capacities assume that the machine is on firm, level ground.
  4. Lift capacities may be limited by local regulations. Please refer to your dealer.



LIFT CAPACITIES – DIPPER LENGTH: 1.91M, TAB 5.35M, NO BUCKET, FRONT DOZER, REAR STABILISERS, 4 T COUNTERWEIGHT.													JS200W TAB
Reach	1.5m		3m		4.5m		6m		7.5m		Capacity at Max Reach		
													
Load Point Ht.	kg	kg	kg	kg	kg	kg	kg	kg	kg	kg	kg	kg	mm
7.5m					4770*	4770*					4930*	4930*	4730
6m					4650*	4650*	4760*	4760*			4840*	4840*	6140
4.5m					5720*	5720*	4970*	4970*			4950*	4480	6940
3m					7450*	7450*	5660*	5470			5160*	3970	7341
1.5m					8920*	7900	6400*	5190			5440*	3800	7412
0m					9580*	7680	6920*	5030			5800*	3930	7161
-1.5m					9540*	7680	6980*	5010			6250*	4460	6551
-3m													
-4.5m													

LIFT CAPACITIES – DIPPER LENGTH: 2.4M, TAB 5.35M, NO BUCKET, FRONT DOZER, REAR STABILISERS, 4 T COUNTERWEIGHT.													JS200W TAB
Reach	1.5m		3m		4.5m		6m		7.5m		Capacity at Max Reach		
													
Load Point Ht.	kg	kg	kg	kg	kg	kg	kg	kg	kg	kg	kg	kg	mm
7.5m											4500*	4500*	5430
6m							4270*	4270*			4500*	4500*	6687
4.5m					5190*	5190*	4640*	4640*			4630*	4120	7426
3m			6790*	6790*	6920*	6920*	5390*	5390*	4840*	3960	4840*	3700	7801
1.5m					8560*	8120	6210*	5320	5220*	3830	5110*	3560	7867
0m					9480*	7790	6840*	5110	5530*	3740	5450*	3650	7632
-1.5m			12,340*	12,340*	9700*	7720	7080*	5040			5870*	4050	7065
-3m					9140*	7850					7260*	5740	5543
-4.5m													

LIFT CAPACITIES – DIPPER LENGTH: 3.0M, TAB 5.35M, NO BUCKET, FRONT DOZER, REAR STABILISERS, 4 T COUNTERWEIGHT.													JS200W TAB
Reach	1.5m		3m		4.5m		6m		7.5m		Capacity at Max Reach		
													
Load Point Ht.	kg	kg	kg	kg	kg	kg	kg	kg	kg	kg	kg	kg	mm
7.5m							3730*	3730*			3590*	3590*	6205
6m							3560*	3560*			3270*	3270*	7325
4.5m					4290*	4290*	4010*	4010*	3980*	3980*	3170*	3170*	8003
3m			9760*	9760*	6010*	6010*	4810*	4810*	4330*	3940	3210*	3210*	8352
1.5m					7800*	7800*	5710*	5310	4800*	3780	3390*	3140	8413
0m			6900*	6900*	9020*	7760	6470*	5050	5220*	3640	3740*	3200	8194
-1.5m			11,470*	11,470*	9530*	7580	6890*	4920	5400*	3590	4390*	3490	7670
-3m					9330*	7630	6770*	4940			5740*	4210	6767
-4.5m													

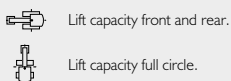

Notes:

1. For lifting capacity including bucket, subtract total weight of bucket or bucket and quickhitch from above values.
2. Lifting capacities are based on ISO 10567, that is: 75% of minimum tipping load or 87% of hydraulic lift capacity, whichever is the less. Lifting capacities marked\* are based on hydraulic capacity.
3. Lift capacities assume that the machine is on firm, level ground.
4. Lift capacities may be limited by local regulations. Please refer to your dealer.

**LIFT CAPACITIES – DIPPER LENGTH: 1.91M, TAB 5.35M, NO BUCKET, REAR STABILISERS, 4 T COUNTERWEIGHT. JS200W TAB**

Reach	1.5m		3m		4.5m		6m		7.5m		Capacity at Max Reach		
													
Load Point Ht.	kg	kg	kg	kg	kg	kg	kg	kg	kg	kg	kg	kg	mm
7.5m					4770*	4770*					4930*	4930*	4730
6m					4650*	4650*	4760*	4450			4840*	4250	6140
4.5m					5720*	5720*	4970*	4330			4950*	3350	6940
3m					7450*	6170	5660*	4060			5160*	2940	7341
1.5m					8920*	5630	6400*	3800			5320	2790	7412
0m					9580*	5430	6920*	3640			5540	2870	7161
-1.5m					9540*	5430	6890*	3620			6250*	3250	6551
-3m													
-4.5m													

**LIFT CAPACITIES – DIPPER LENGTH: 2.4M, TAB 5.35M, NO BUCKET, REAR STABILISERS, 4 T COUNTERWEIGHT. JS200W TAB**







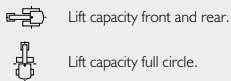





Reach	1.5m		3m		4.5m		6m		7.5m		Capacity at Max Reach		
													
Load Point Ht.	kg	kg	kg	kg	kg	kg	kg	kg	kg	kg	kg	kg	mm
7.5m											4500*	4500*	5430
6m							4270*	4270*			4500*	3810	6687
4.5m			6790*	6790*	5190*	5190*	4640*	4510			4630*	3100	7426
3m					6920*	6450	5390*	4210	4840*	2960	4840*	2760	7801
1.5m					8560*	5840	6210*	3920	5220*	2830	4920	2630	7867
0m					9480*	5540	6840*	3720	5210	2740	5080	2680	7632
-1.5m			12,340*	10,620	9700*	5470	7080	3660			5680	2970	7065
-3m					9140*	5580					7260*	4170	5543
-4.5m													













**LIFT CAPACITIES – DIPPER LENGTH: 3.0M, TAB 5.35M, NO BUCKET, REAR STABILISERS, 4 T COUNTERWEIGHT. JS200W TAB**













Reach	1.5m		3m		4.5m		6m		7.5m		Capacity at Max Reach		
													
Load Point Ht.	kg	kg	kg	kg	kg	kg	kg	kg	kg	kg	kg	kg	mm
7.5m							3730*	3730*			3590*	3590*	6205
6m							3560*	3560*			3270*	3240	7325
4.5m					4290*	4290*	4010*	4010*	3980*	3070	3170*	2690	8003
3m			9760*	9760*	6010*	6010*	4810*	4230	4330*	2930	3210*	2410	8352
1.5m					7800*	5920	5710*	3900	4800*	2770	3390*	2290	8413
0m			6900*	6900*	9020*	5490	6470*	3650	5110	2640	3740*	2320	8194
-1.5m			11,470*	10,340	9530*	5330	6890*	3530	5060	2600	4390*	2520	7670
-3m					9330*	5090	6770*	3560			5740	3050	6767
-4.5m													



- Notes:**
1. For lifting capacity including bucket, subtract total weight of bucket or bucket and quickhitch from above values.
  2. Lifting capacities are based on ISO 10567, that is: 75% of minimum tipping load or 87% of hydraulic lift capacity, whichever is the less. Lifting capacities marked\* are based on hydraulic capacity.
  3. Lift capacities assume that the machine is on firm, level ground.
  4. Lift capacities may be limited by local regulations. Please refer to your dealer.

LIFT CAPACITIES – DIPPER LENGTH: 1.91M, TAB 5.35M, NO BUCKET, 4 STABILISERS, 4 T COUNTERWEIGHT.													JS200W TAB
Reach	1.5m		3m		4.5m		6m		7.5m		Capacity at Max Reach		
													
Load Point Ht.	kg	kg	kg	kg	kg	kg	kg	kg	kg	kg	kg	kg	mm
7.5m					4770*	4770*					4930*	4930*	4730
6m					4650*	4650*	4760*	4760*			4840*	4840*	6140
4.5m					5720*	5720*	4970*	4970*			4950*	4950*	6940
3m					7450*	7450*	5660*	5660*			5160*	5020	7341
1.5m					8920*	8920*	6400*	6400*			5440*	4830	7412
0m					9580*	9580*	6920*	6470			5800*	5010	7161
-1.5m					9540*	9540*	6980*	6450			6250*	5710	6551
-3m													
-4.5m													

LIFT CAPACITIES – DIPPER LENGTH: 2.4M, TAB 5.35M, NO BUCKET, FRONT DOZER, REAR STABILISERS, 4 T COUNTERWEIGHT.													JS200W TAB
Reach	1.5m		3m		4.5m		6m		7.5m		Capacity at Max Reach		
													
Load Point Ht.	kg	kg	kg	kg	kg	kg	kg	kg	kg	kg	kg	kg	mm
7.5m											4500*	4500*	5430
6m							4270*	4270*			4500*	4500*	6687
4.5m					5190*	5190*	4640*	4640*			4630*	4630*	7426
3m			6790*	6790*	6920*	6920*	5390*	5390*	4840*	4840*	4840*	4660	7801
1.5m					8560*	8560*	6210*	6210*	5220*	4840	5110*	4500	7867
0m					9480*	9480*	6840*	6560	5530*	4740	5450*	4630	7632
-1.5m			12,340*	12,340*	9700*	9700*	7080*	6480			5870*	5150	7065
-3m					9140*	9140*					7260*	7260*	5543
-4.5m													

LIFT CAPACITIES – DIPPER LENGTH: 3.0M, TAB 5.35M, NO BUCKET, 4 STABILISERS, 4 T COUNTERWEIGHT.													JS200W TAB
Reach	1.5m		3m		4.5m		6m		7.5m		Capacity at Max Reach		
													
Load Point Ht.	kg	kg	kg	kg	kg	kg	kg	kg	kg	kg	kg	kg	mm
7.5m								3730*	3730*			3590*	6205
6m								3560*	3560*			3270*	7325
4.5m					4290*	4290*	4010*	4010*	3980*	3980*	3170*	3170*	8003
3m			9760*	9760*	6010*	6010*	4810*	4810*	4330*	4330*	3210*	3210*	8352
1.5m					7800*	7800*	5710*	5710*	4800*	4790	3390*	3390*	8413
0m			6900*	6900*	9020*	9020*	6470*	6470*	5220*	4650	3740*	3740*	8194
-1.5m			11,470*	11,470*	9530*	9530*	6890*	6360	5400*	4600	4390*	4390*	7670
-3m					9330*	9330*	6770*	6380			5740*	5390	6767
-4.5m													

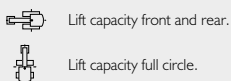

Notes:

1. For lifting capacity including bucket, subtract total weight of bucket or bucket and quickhitch from above values.
2. Lifting capacities are based on ISO 10567, that is: 75% of minimum tipping load or 87% of hydraulic lift capacity, whichever is the less. Lifting capacities marked\* are based on hydraulic capacity.
3. Lift capacities assume that the machine is on firm, level ground.
4. Lift capacities may be limited by local regulations. Please refer to your dealer.



**LIFT CAPACITIES – DIPPER LENGTH: 1.91M, TAB 5.35M, NO BUCKET, REAR DOZER, 4 T COUNTERWEIGHT. JS200W TAB**

Reach	1.5m		3m		4.5m		6m		7.5m		Capacity at Max Reach		
													
Load Point Ht.	kg	kg	kg	kg	kg	kg	kg	kg	kg	kg	kg	kg	mm
7.5m					4770*	4770*					4930*	4930*	4730
6m					4650*	4650*	4760*	3490			4840*	3320	6140
4.5m					5720*	5350	4970*	3370			4950*	2580	6940
3m					7450*	4680	5660*	3110			5160*	2230	7341
1.5m					8920*	4170	6400*	2860			5440*	2090	7412
0m					9580*	3980	6920*	2710			5800*	2140	7161
-1.5m					9540*	3980	6980*	2690			6250*	2430	6551
-3m													
-4.5m													

**LIFT CAPACITIES – DIPPER LENGTH: 2.4M, TAB 5.35M, NO BUCKET, REAR DOZER, 4 T COUNTERWEIGHT. JS200W TAB**





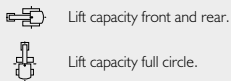

Reach	1.5m		3m		4.5m		6m		7.5m		Capacity at Max Reach		
													
Load Point Ht.	kg	kg	kg	kg	kg	kg	kg	kg	kg	kg	kg	kg	mm
7.5m											4500*	4350	5430
6m							4270*	3700			4500*	2990	6687
4.5m			6790*	6790*	5190*	5190*	4640*	3540			4630*	2400	7426
3m					6920*	4940	5390*	3260	4840*	2270	4840*	2100	7801
1.5m					8560*	4370	6210*	2980	5220*	2150	5110*	1980	7867
0m					9480*	4090	6840*	2790	5530*	2060	5450*	2010	7632
-1.5m			12,340*	7490	9700*	4020	7080*	2730			5870*	2230	7065
-3m					9140*	4130					7260*	3120	5543
-4.5m													



**LIFT CAPACITIES – DIPPER LENGTH: 3.0M, TAB 5.35M, NO BUCKET, REAR DOZER, 4 T COUNTERWEIGHT. JS200W TAB**













Reach	1.5m		3m		4.5m		6m		7.5m		Capacity at Max Reach		
													
Load Point Ht.	kg	kg	kg	kg	kg	kg	kg	kg	kg	kg	kg	kg	mm
7.5m							3760*	3740*			3570*	3590	6205
6m							3580*	3580*			3250*	2540	7325
4.5m					4320*	4320*	4050*	3600	4030*	2400	3150*	2090	8003
3m			9880*	9330	6080*	5140	4870*	3310	4380*	2280	3190*	1850	8352
1.5m					7900*	4520	5790*	3010	4860*	2130	3370*	1740	8413
0m			6880*	6880*	9140*	4140	6550*	2790	5290*	2010	3730*	1760	8194
-1.5m			11,440*	7430	9650*	4000	6980*	2680	5470*	1970	4380*	1910	7670
-3m					9450*	4030	6860*	2700			5730*	2320	6767
-4.5m													



- Notes:**
1. For lifting capacity including bucket, subtract total weight of bucket or bucket and quickhitch from above values.
  2. Lifting capacities are based on ISO 10567, that is: 75% of minimum tipping load or 87% of hydraulic lift capacity, whichever is the less. Lifting capacities marked\* are based on hydraulic capacity.
  3. Lift capacities assume that the machine is on firm, level ground.
  4. Lift capacities may be limited by local regulations. Please refer to your dealer.

LIFT CAPACITIES – DIPPER LENGTH: 1.9M, 5.35M TAB, NO BUCKET, FRONT DOZER, REAR STABILISERS, 4.5T COUNTERWEIGHT													JS200W MONO
Reach	1.5m		3m		4.5m		6m		7.5m		Capacity at Max Reach		
													
Load Point Ht.	kg	kg	kg	kg	kg	kg	kg	kg	kg	kg	kg	kg	mm
7.5m					4770*	4770*					4930*	4930*	4730
6m					4650*	4650*	4760*	4760*			4840*	4840*	6140
4.5m					5720*	5720*	4970*	4970*			4950*	4730	6940
3m					7450*	7450*	5660*	5660*			5160*	4210	7341
1.5m					8920*	8370	6400*	5500			5440*	4040	7412
0m					9580*	8140	6920*	5330			5800*	4170	7161
-1.5m					9540*	8140	6980*	5320			6250*	4740	6551
-3m													
-4.5m													

LIFT CAPACITIES – DIPPER LENGTH: 2.4M, 5.35M TAB, NO BUCKET, FRONT DOZER, REAR STABILISERS, 4.5T COUNTERWEIGHT													JS200W MONO
Reach	1.5m		3m		4.5m		6m		7.5m		Capacity at Max Reach		
													
Load Point Ht.	kg	kg	kg	kg	kg	kg	kg	kg	kg	kg	kg	kg	mm
7.5m											4500*	4500*	5430
6m							4270*	4270*			4500*	4500*	6687
4.5m			6790*	6790*	5190*	5190*	4640*	4640*			4630*	4370	7426
3m					6920*	6920*	5390*	5390*	4840*	4200	4840*	3930	7801
1.5m					8560*	8560*	6210*	5640	5220	4070	5110*	3780	7867
0m					9480*	8280	6840*	5430	5530*	3980	5450*	3880	7632
-1.5m			12340*	12340*	9700*	8200	7080*	5360			5870*	4310	7065
-3m					9140*	8330					7260*	6100	5543
-4.5m													

LIFT CAPACITIES – DIPPER LENGTH: 3M, 5.35M TAB, NO BUCKET, FRONT DOZER, REAR STABILISERS, 4.5T COUNTERWEIGHT													JS200W MONO
Reach	1.5m		3m		4.5m		6m		7.5m		Capacity at Max Reach		
													
Load Point Ht.	kg	kg	kg	kg	kg	kg	kg	kg	kg	kg	kg	kg	mm
7.5m							3730*	3730*			3590*	3590*	6205
6m							3560*	3560*			3270*	3270*	7325
4.5m					4290*	4290*	4010*	4010*	3980*	3980*	3170*	3170*	8003
3m			9760	9760	6010	6010	4810	4500	4330	3140	3210	2590	3852
1.5m					7800	6310	5710	4170	4800	2980	3390	2470	8413
0m			6900	6900	9020	5890	6470	3920	5220	2850	3740	2500	8194
-1.5m			11470	11470	9530	5730	6890	3800	5350	2800	4390	2720	7670
-3m					9330	5770	6770	3820			5740	3280	6767
-4.5m													

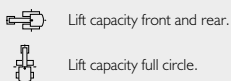

Notes:

1. For lifting capacity including bucket, subtract total weight of bucket or bucket and quickhitch from above values.
2. Lifting capacities are based on ISO 10567, that is: 75% of minimum tipping load or 87% of hydraulic lift capacity, whichever is the less. Lifting capacities marked\* are based on hydraulic capacity.
3. Lift capacities assume that the machine is on firm, level ground.
4. Lift capacities may be limited by local regulations. Please refer to your dealer.

LIFT CAPACITIES – DIPPER LENGTH: 1.9, 5.35M TAB, NO BUCKET, REAR STABILISERS, 4.5T COUNTERWEIGHT													JS200W MONO
Reach	1.5		3m		4.5m		6m		7.5m		Capacity at Max Reach		
													
Load Point Ht.	kg	kg	kg	kg	kg	kg	kg	kg	kg	kg	kg	kg	mm
7.5m					4770*	4770*					4930*	4930*	4730
6m					4650*	4650*	4760*	4760*			4840*	4800	6140
4.5m					5720*	5720*	4970*	4900			4950*	3810	6940
3m					7450*	7040	5660*	4620			5160*	3360	7341
1.5m					8920*	6500	6400*	4360			5440*	3210	7412
0m					9580*	6270	7000*	4170			5800*	3310	7161
-1.5m					9540*	6290	6980*	4180			6250*	3740	6551
-3m													
-4.5m													





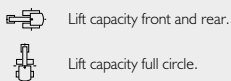







LIFT CAPACITIES – DIPPER LENGTH: 2.4, 5.35M TAB, NO BUCKET, REAR STABILISERS, 4.5T COUNTERWEIGHT													JS200W MONO
Reach	1.5m		3m		4.5m		6m		7.5m		Capacity at Max Reach		
													
Load Point Ht.	kg	kg	kg	kg	kg	kg	kg	kg	kg	kg	kg	kg	mm
7.5m											4500*	4500*	5430
6m							4270*	4270*			4500*	4300	6687
4.5m			6790*	6790*	5190*	5190*	4640*	4640*			4630*	3520	7426
3m					6920*	6920*	5390	4780	4840*	3370	4840*	3150	7801
1.5m					8560*	6710	6210*	4490	5220*	3250	5110*	3020	7867
0m					9480*	6400	6840*	4280	5220	3160	5380	3080	7632
-1.5m			12340*	12340*	9700*	6330	7080*	4220			5870*	3410	7065
-3m					9140*	6450					7260*	4790	5543
-4.5m													













LIFT CAPACITIES – DIPPER LENGTH: 3M, 5.35M TAB, NO BUCKET, REAR STABILISERS, 4.5T COUNTERWEIGHT													JS200W MONO
Reach	1.5m		3m		4.5m		6m		7.5m		Capacity at Max Reach		
													
Load Point Ht.	kg	kg	kg	kg	kg	kg	kg	kg	kg	kg	kg	kg	mm
7.5m							3730*	3730*			3590*	3590*	6205
6m							3560*	3560*			3270*	3270*	7325
4.5m					4290*	4290*	4010*	4010*	3980*	3490	3170*	3070	8003
3m			9760*	9760*	6010*	6010*	4810*	4800	4330*	3350	3210*	2770	8352
1.5m					7800*	6790	5710*	4470	4800*	3190	3390*	2650	8413
0m			6900*	6900*	9020*	6360	6470*	4220	5220	3060	3740*	2690	8194
-1.5m			11470*	11470*	9530*	6190	6890*	4090	5370	3010	4390*	2920	7670
-3m					9330*	6240	6770*	4110			5740*	3520	6767
-4.5m													















- Notes:
1. For lifting capacity including bucket, subtract total weight of bucket or bucket and quickhitch from above values.
  2. Lifting capacities are based on ISO 10567, that is: 75% of minimum tipping load or 87% of hydraulic lift capacity, whichever is the less. Lifting capacities marked\* are based on hydraulic capacity.
  3. Lift capacities assume that the machine is on firm, level ground.
  4. Lift capacities may be limited by local regulations. Please refer to your dealer.



LIFT CAPACITIES – DIPPER LENGTH: 1.9M, 5.35M TAB, NO BUCKET, FRONT STABILISERS, REAR STABILISERS, 4.5T COUNTERWEIGHT													JS200W MONO
Reach	1.5m		3m		4.5m		6m		7.5m		Capacity at Max Reach		
													
Load Point Ht.	kg	kg	kg	kg	kg	kg	kg	kg	kg	kg	kg	kg	mm
7.5m					4770*	4770*					4930*	4930*	4730
6m					4650*	4650*	4760*	4760*			4840*	4840*	6140
4.5m					5720*	5720*	4970*	4970*			4950*	4950*	6940
3m					7450*	7450*	5660*	5660*			5160*	5160*	7341
1.5m					8920*	8920*	6400*	6400*			5440*	5100	7412
0m					9580*	9580*	6920*	6820			5800*	5290	7161
-1.5m					9540*	9540*	6980*	6810			6250*	6020	6551
-3m					9330*	5770	6770*	3820			5740*	3280	6767
-4.5m													

LIFT CAPACITIES – DIPPER LENGTH: 2.4, 5.35M TAB, NO BUCKET, FRONT STABILISERS, REAR STABILISERS, 4.5T COUNTERWEIGHT													JS200W MONO
Reach	1.5m		3m		4.5m		6m		7.5m		Capacity at Max Reach		
													
Load Point Ht.	kg	kg	kg	kg	kg	kg	kg	kg	kg	kg	kg	kg	mm
7.5m											4480*	4480*	5925
6m							4270*	4270*			4500*	4500*	6687
4.5m			6790*	6790*	5190*	5190*	4640*	4640*			4630*	4630*	7426
3m					6920*	6920*	5390*	5390*	4840*	4840*	4840*	4840*	7801
1.5m					8560*	8560*	6210*	6210*	5220*	5100	5110*	4740	7867
0m					9480*	9480*	6840*	6840*	5530*	5010	5450*	4880	7632
-1.5m			12340*	12340*	9700*	9700*	7080*	6840			5870*	5440	7065
-3m					9140*	9140*					7260*	7260*	5543
-4.5m													

LIFT CAPACITIES – DIPPER LENGTH: 3M, 5.35M TAB, NO BUCKET, FRONT STABILISERS, REAR STABILISERS, 4.5T COUNTERWEIGHT													JS200W MONO
Reach	1.5m		3m		4.5m		6m		7.5m		Capacity at Max Reach		
													
Load Point Ht.	kg	kg	kg	kg	kg	kg	kg	kg	kg	kg	kg	kg	mm
7.5m							3730*	3730*			3590*	3590*	6205
6m							3560*	3560*			3270*	3270*	7325
4.5m					4290*	4290*	4010*	4010*	3980*	3980*	3170*	3170*	8003
3m			9760*	9760*	6010*	6010*	4810*	4810*	4330*	4330*	3210*	3210*	8352
1.5m					7800*	7800*	5710*	5710*	4800*	4800*	3390*	3390*	8413
0m			6900*	6900*	9020*	9020*	6470*	6470*	5220*	4910	3740*	3740*	8194
-1.5m			11470*	11470*	9530*	9530*	6890*	6710	5400*	4860	4390*	4390*	7670
-3m					9330*	9330*	6770*	6740			5740*	5690	6767
-4.5m													

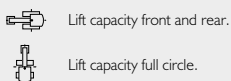

Notes:

1. For lifting capacity including bucket, subtract total weight of bucket or bucket and quickhitch from above values.
2. Lifting capacities are based on ISO 10567, that is: 75% of minimum tipping load or 87% of hydraulic lift capacity, whichever is the less. Lifting capacities marked\* are based on hydraulic capacity.
3. Lift capacities assume that the machine is on firm, level ground.
4. Lift capacities may be limited by local regulations. Please refer to your dealer.

LIFT CAPACITIES – DIPPER LENGTH 1.9M, TAB 5.35, NO BUCKET, REAR DOZER, 4.5 T COUNTERWEIGHT													JS200W MONO
Reach	1.5m		3m		4.5m		6m		7.5m		Capacity at Max Reach		
													
Load Point Ht.	kg	kg	kg	kg	kg	kg	kg	kg	kg	kg	kg	kg	mm
7.5m					4770*	4770*					4930*	4930*	4730
6m					4650*	4650*	4760*	3990			4840*	3810	6140
4.5m					5720*	5720*	4970*	3880			4950*	2990	6940
3m					7450*	5430	5660*	3610			5160*	2610	7341
1.5m					8920*	4920	7810*	4290			5440*	2470	7412
0m					9580*	4720	6920*	3200			5800*	2530	7161
-1.5m					9540*	4720	6980*	3190			6250*	2870	6551
-3m													
-4.5m													

LIFT CAPACITIES – DIPPER LENGTH 2.4M, TAB 5.35, NO BUCKET, REAR DOZER, 4.5 T COUNTERWEIGHT													JS200W MONO
Reach	1.5m		3m		4.5m		6m		7.5m		Capacity at Max Reach		
													
Load Point Ht.	kg	kg	kg	kg	kg	kg	kg	kg	kg	kg	kg	kg	mm
7.5m													
6m							4720*	4210				4500*	6687
4.5m			6790*	6790*	5190*	5190*	4640*	4040				4630*	7426
3m					6920*	5700	5390*	3760	4840*	2640		4840*	7801
1.5m					8560*	5120	6210*	3480	5220*	2520		5110*	7867
0m					9480*	4820	6840*	3290	5530*	2430		5450*	7632
-1.5m			12340*	8940	9700*	4760	7080*	3220				5870*	7065
-3m					9140*	4870						7260*	5543
-4.5m													

LIFT CAPACITIES – DIPPER LENGTH 3M, TAB 5.35, NO BUCKET, REAR DOZER, 4.5 T COUNTERWEIGHT													JS200W MONO
Reach	1.5m		3m		4.5m		6m		7.5m		Capacity at Max Reach		
													
Load Point Ht.	kg	kg	kg	kg	kg	kg	kg	kg	kg	kg	kg	kg	mm
7.5m							3760*	3760*				3570*	6205
6m							3580*	3580*				3250*	7325
4.5m					4320*	4320*	4050*	3840	4030*	2580		3150*	8003
3m			9880*	9880*	6080*	5490*	4870*	3550	4380*	2460		3190*	8352
1.5m					7900*	4870	5790*	3260	4860*	2320		3370*	8413
0m			6880	6880*	9140*	4490	6550*	3030	5290*	2200		3730*	8194
-1.5m			11440*	8040	11040*	5150	6980*	2920	5470*	2150		4380*	7670
-3m					10700*	5210	6860*	2940				5370*	6767
-4.5m													

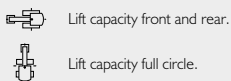

- Notes:
1. For lifting capacity including bucket, subtract total weight of bucket or bucket and quickhitch from above values.
  2. Lifting capacities are based on ISO 10567, that is: 75% of minimum tipping load or 87% of hydraulic lift capacity, whichever is the less. Lifting capacities marked\* are based on hydraulic capacity.
  3. Lift capacities assume that the machine is on firm, level ground.
  4. Lift capacities may be limited by local regulations. Please refer to your dealer.









**ONE COMPANY, OVER 300 MACHINES.**

Your nearest JCB dealer

**Wheeled Excavator JS200W**

Engine power: 129kW (172hp) Operating weight: 20475 - 23773kg  
 Bucket capacity: 0.4 - 1.18m<sup>3</sup>

JCB Sales Limited, Rokester, Staffordshire, United Kingdom ST14 5JP.  
 Tel: +44 (0)1889 590312 Email: salesinfo@jcb.com  
 Download the very latest information on this product range at: [www.jcb.com](http://www.jcb.com)

©2009 JCB Sales. All rights reserved. No part of this publication may be reproduced, stored in a retrieval system, or transmitted in any form or by any other means, electronic, mechanical, photocopying or otherwise, without prior permission from JCB Sales. All references in this publication to operating weights, sizes, capacities and other performance measurements are provided for guidance only and may vary dependant upon the exact specification of machine. They should not therefore be relied upon in relation to suitability for a particular application. Guidance and advice should always be sought from your JCB Dealer. JCB reserves the right to change specifications without notice. Illustrations and specifications shown may include optional equipment and accessories. All images are correct at time of print. The JCB logo is a registered trademark of J C Bamford Excavators Ltd.

