



507-42, 509-42, 510-42,
510-56, 512-56, 514-56

QUICK REFERENCE GUIDE

This Quick Reference Guide DOES NOT replace the Operators Manual. You MUST read ALL the disclaimers and safety and other instructions in the Operators Manual before initially operating this product. Accordingly, no legal claims can be entertained based on the data, illustrations or descriptions in this Quick Reference Guide.

BEST PRACTICES

1. Carry a load as low as possible while maintaining good visibility.
2. Forks should be tilted back when in transport – with or without a load, cradle the load.
3. Fork tips should be on the ground when unit is parked.
4. Rather than driving into the load, extend the boom to easier see the forks in the load.

Static Dimensions

Machine model	506-36	507-42	509-42	510-42	510-56	512-56	514-56
A Overall height	ft-in 8-3				ft-in 8-10		ft-in 8-11
B Overall width over tyres	ft-in 7-10				ft-in 8-1		
C Inside width of cab	ft-in 3-1						
D Front track	ft-in 6-4		ft-in 6-7				
E Wheelbase	ft-in 10-4						
F Overall length to front tyres	ft-in 17-1	ft-in 17-8	ft-in 17	ft-in 17-8	ft-in 17-9	ft-in 18-4	
G Overall length to front of carriage	ft-in 19-5	ft-in 21-3	ft-in 20-7	ft-in 21-3	ft-in 21-7	ft-in 22-4	
H Ground clearance	ft-in 1-3.5				ft-in 1-5.5		
Weight	lbs 20,270	lbs 21,300	lbs 22,430	lbs 23,858	lbs 29,900	lbs 30,635	lbs 32,143

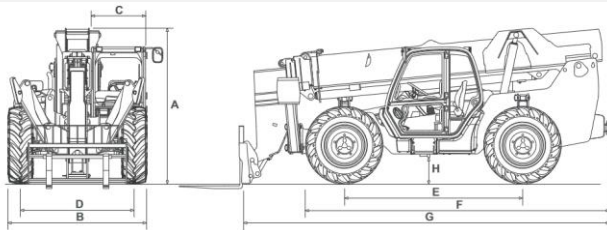

Tie Down Points

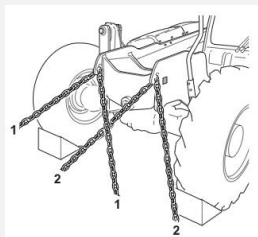

Front Anchor Points

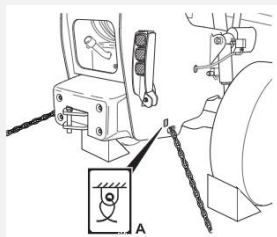

Rear Anchor Points

Cab Layout

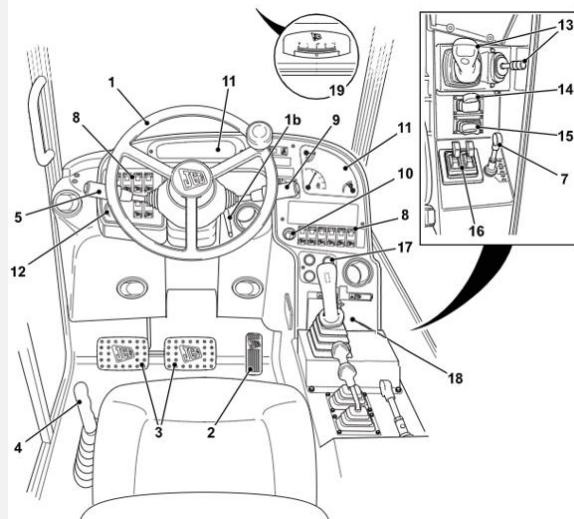

1. Steering Wheel
2. Accelerator Pedal
3. Foot Brake Pedal
4. Park Brake Lever
5. Transmission Lever (4-Speed Transmission)
7. Steer Mode Selector
8. Console Switches
9. Multi-Purpose Steering Column Switch (4-Speed Transmission)
10. Starter Switch
11. Instrument Panel
12. Hourmeter
13. Boom and Carriage Controls
14. Auxiliary Controls
15. Chassis Leveling (Sway) Controls
16. Stabilizer Controls (if fitted)
17. Air Conditioning and Cab Heater Controls
18. Load Charts
19. Inclinometer

Instrument Panel

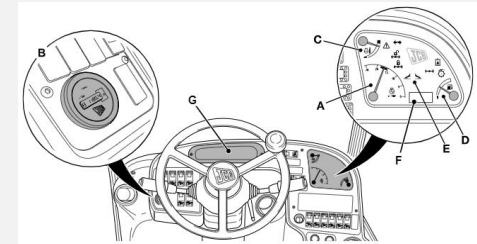

- | | |
|------------------------------|--------------------|
| A. Tachometer | E. Warning Lights |
| B. Hourmeter | F. Digital Display |
| C. Coolant Temperature Gauge | G. Warning Lights |
| D. Fuel Level Gauge | |

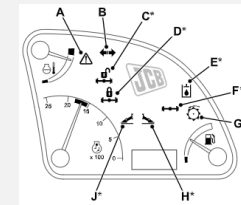

- | |
|--|
| A. Malfunction Indicator Lamp (MIL) |
| B. Not used |
| C. RAS System – Cushioned Mode Indicator |
| D. RAS System – Locked Mode Indicator |
| E. Hydraulic Isolation – Fault Indicator |
| F. RAS System – Fault Indicator |
| G. Not used |
| H. Right-Hand Stabilizer Indicator |
| I. Left-Hand Stabilizer Indicator |

Start Up Sequence

<p>1. Insert Isolator Key (A)</p> <p>Insert battery isolator key switch, push and turn 90° (degrees symbol)</p>	<p>2. Disarm the immobiliser</p> <p>If installed, clear with MID then key in the code followed by enter.</p>	<p>3. Set to Neutral</p> <p>Put the forward / reverse lever into neutral.</p>
<p>4. Insert Key</p> <p>Insert key into ignition switch (A)</p>	<p>5. Start Machine</p> <p>Turn the ignition key to the start position (position II) and hold it there until the engine starts.</p>	<p>6. Operate Hydraulics</p> <p>Operate the hydraulic services to make sure that each function is working correctly and to help warm up the hydraulic system.</p>

Access additional information

www.servicepro.jcb.com



Single Lever Control

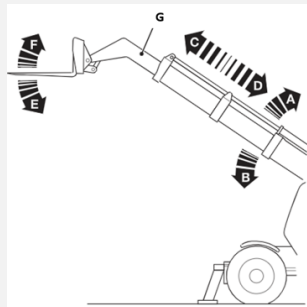
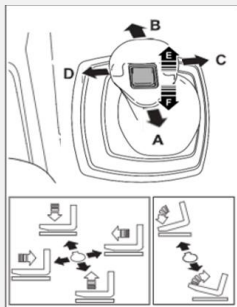

- A. Boom Raise
- B. Boom Lower
- C. Boom Extend
- D. Boom Retract

- E. Carriage Tilt Forward
- F. Carriage Tilt Back
- G. Inner Boom

Auxiliary Control

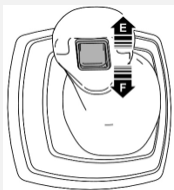

Roll the thumb switch (E) forward or (F) backwards to use desired function

Stabilizer Controls

1. Park the machine on firm ground.
2. Turn off the stabilizer isolation switch (D).
3. Push the control levers (B) forward to lower the stabilizer legs (F).
4. Pull the control levers (C) back to raise the stabilizer legs (E).
5. Before you operate the boom, make sure the machine is level and stabilizer controls are isolated.

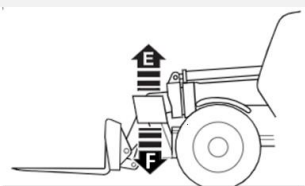

- A. Stabilizer control levers
- B. Stabilizer legs- lower
- C. Stabilizer legs – raise
- D. Stabilizer isolation switch

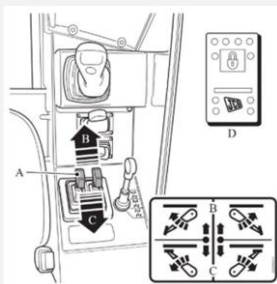

Chassis Levelling (Sway) Operation

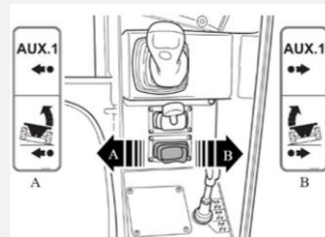

To operate move the lever to either the right or left until the machine shows as level on the inclinometer.

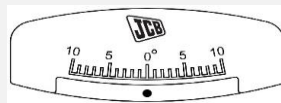

Vehicle Steer Mode - Manual

1. Stop the machine. Set the gear lever to the neutral position
2. Turn the steering wheel until all the wheels are pointing in the straight ahead position
3. Use the lever (A) to select the steering mode:
 - B. 4 wheel steer
 - C. 2 wheel steer
 - D. Crab steer
4. Operate the steering wheel until the wheels straighten up to re-phase the mode.



Access Covers

Engine Compartment

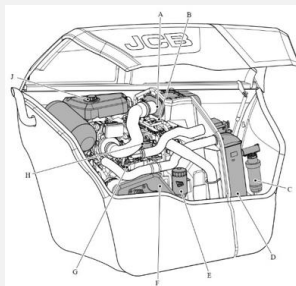

- A. Air Filter
- B. Transmission Oil Dipstick
- C. Water Separator
- D. Radiator
- E. Engine Oil Filter
- F. Drive Belt Guard
- G. Engine Oil Dipstick
- H. Engine Oil Filler Cap
- J. Coolant Expansion Tank

Access Covers

Battery Compartment

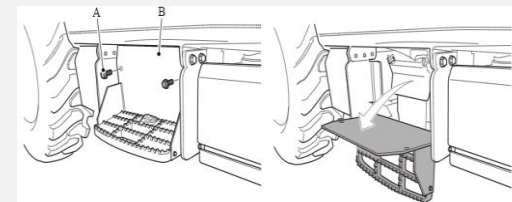

1. Make the machine safe.
2. Hold the battery cover, then remove the bolts (A)
3. Open cover (B).

Rear Cover

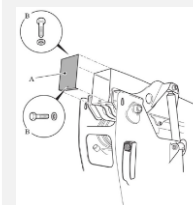

1. Make the machine safe.
2. Hold the lift arm cover (A), then remove the bolts (B)
3. Lower the cover.

Connecting Attachments

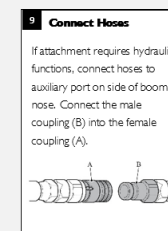
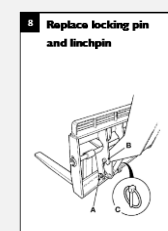
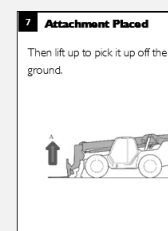
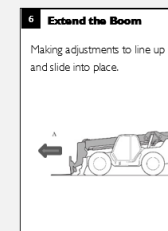
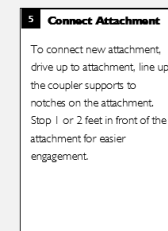
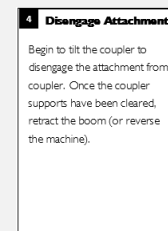
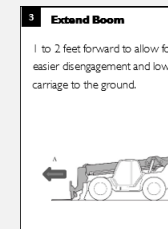
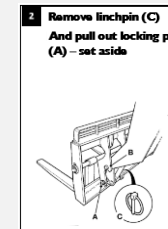
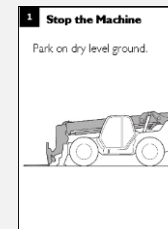

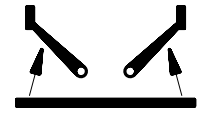

JCB **514 56**
NORTH AMERICA

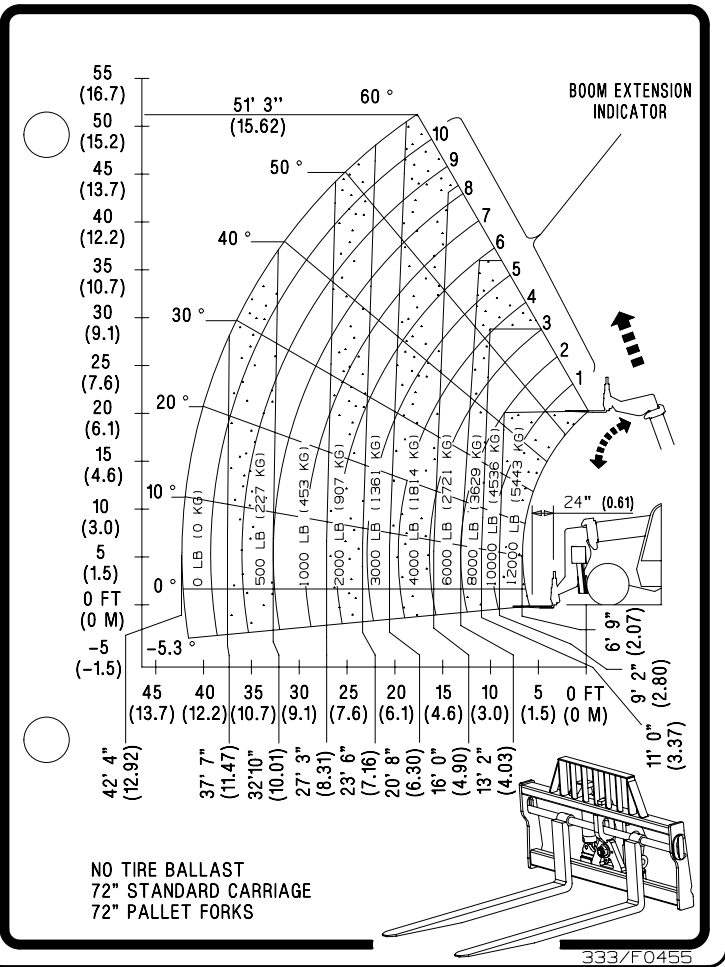

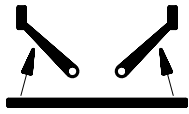

14000 LB LIFT ENVELOPE

NO EXTENSION OF THE BOOM
ALLOWED WITH A LOAD OF 14000 LB

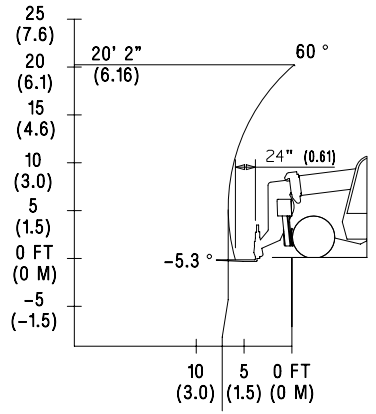

NO TIRE BALLAST
72" SIDE TILT CARRIAGE
72" PALLET FORKS

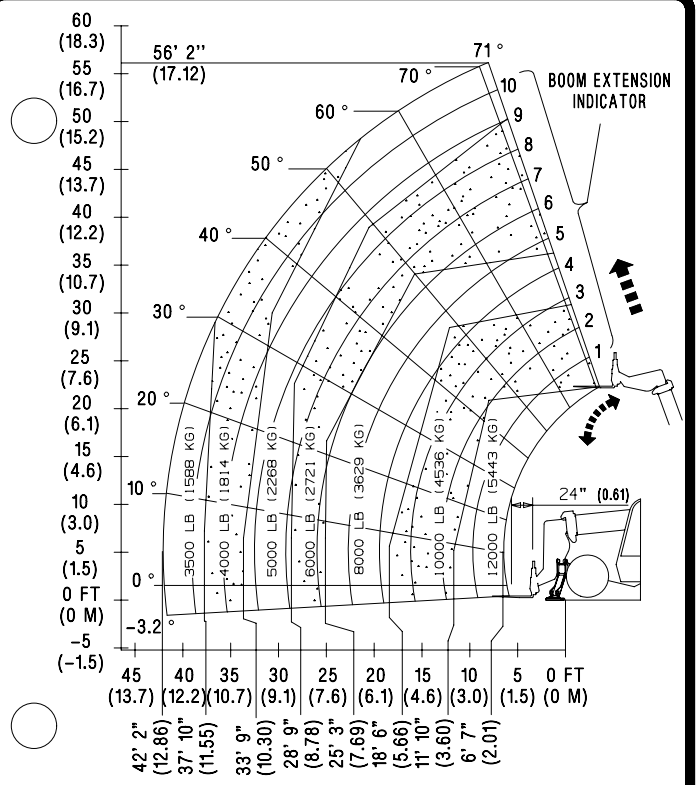
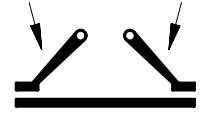
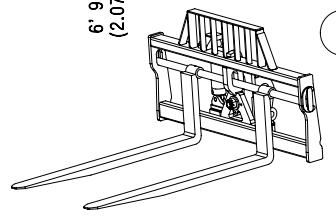

NO TIRE BALLAST
72" SIDE TILT CARRIAGE
72" PALLET FORKS

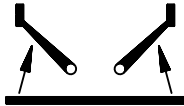

JCB 514 56
NORTH AMERICA

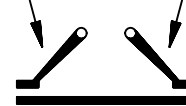
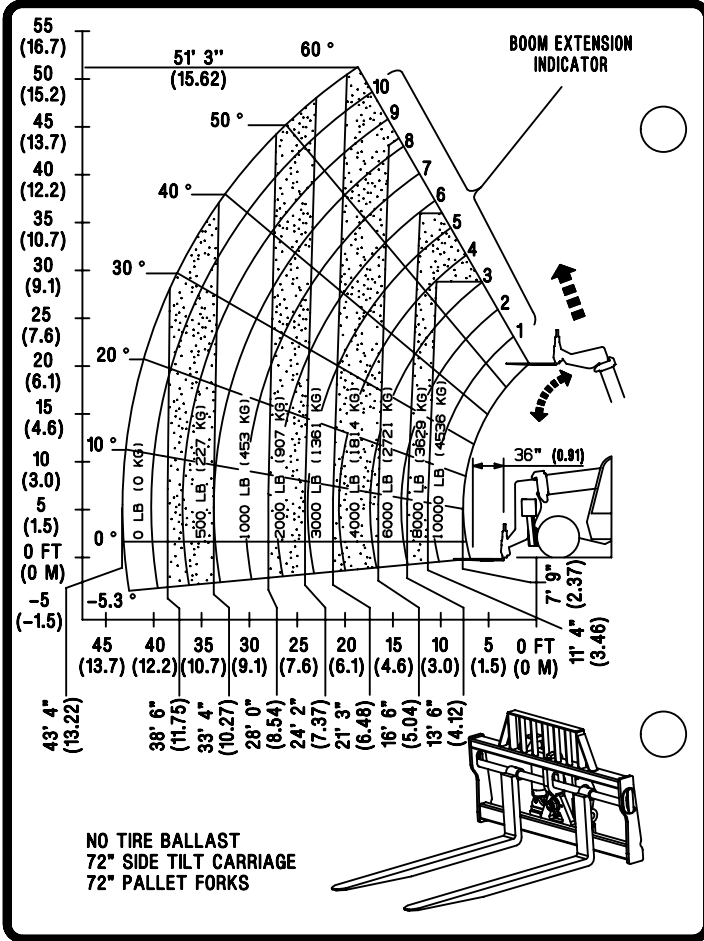

JCB 514 56
NORTH AMERICA

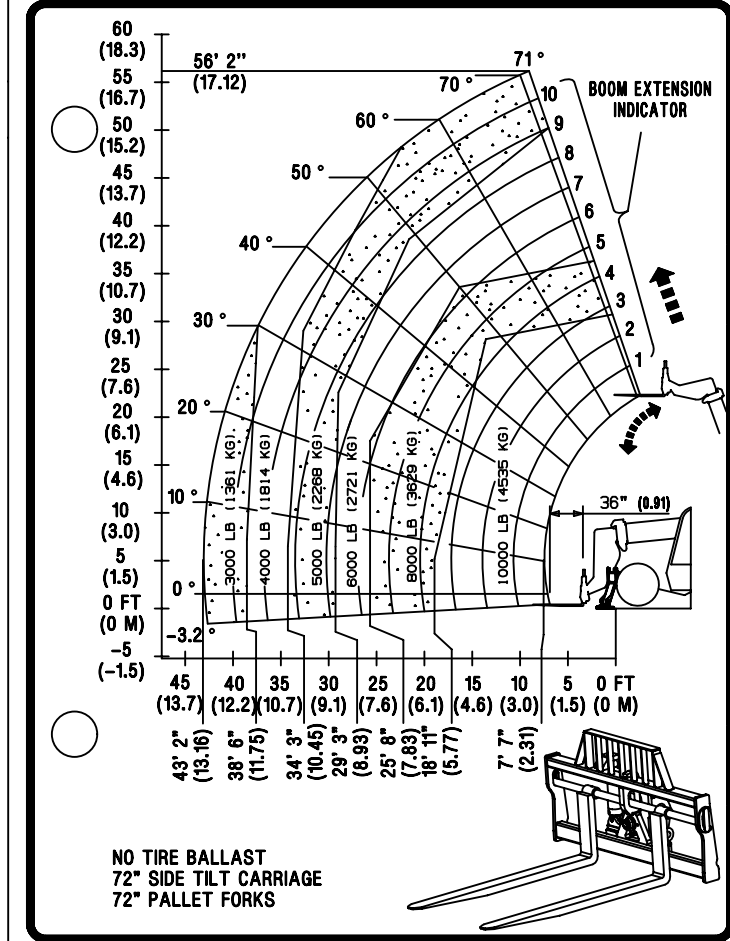

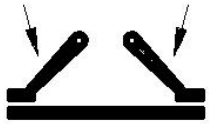

JCB 514 56
NORTH AMERICA

14000 LB LIFT ENVELOPE

NO EXTENSION OF THE BOOM
ALLOWED WITH A LOAD OF 14000 LB

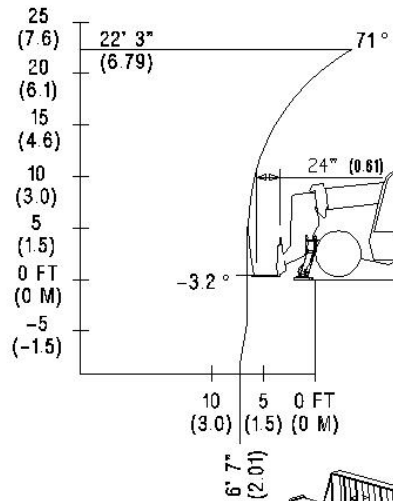

NO TIRE BALLAST
72" SIDE TILT CARRIAGE
72" PALLET FORKS

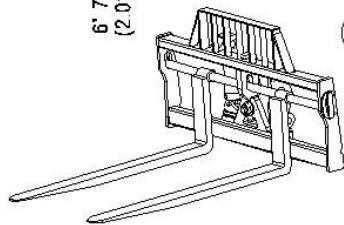

JCB 514 56
NORTH AMERICA

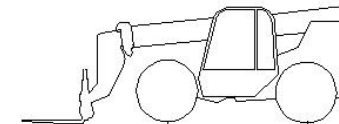

PSI	TIRE SIZE	PR	PSI
83	17.5-25	20	83

INFLATION PRESSURES FOR
PNEUMATIC TIRES ONLY.

TIRES ON THIS VEHICLE MAY
CONTAIN SEALANT OR FOAM
BALLAST.

CONTACT YOUR DEALER FOR
FURTHER INFORMATION.

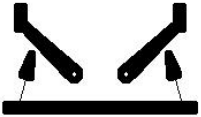

JCB 514 56
NORTH AMERICA

14000 LB LIFT ENVELOPE

NO EXTENSION OF THE BOOM
ALLOWED WITH A LOAD OF 14000 LB

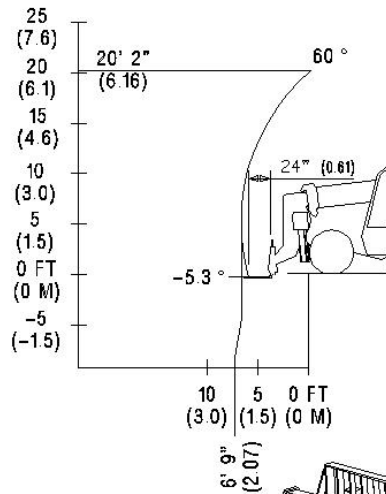

NO TIRE BALLAST
72" SIDE TILT CARRIAGE
72" PALLET FORKS

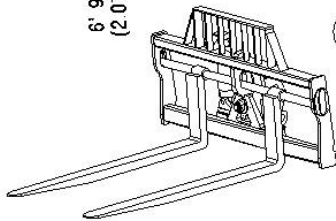

JCB 514 56
NORTH AMERICA

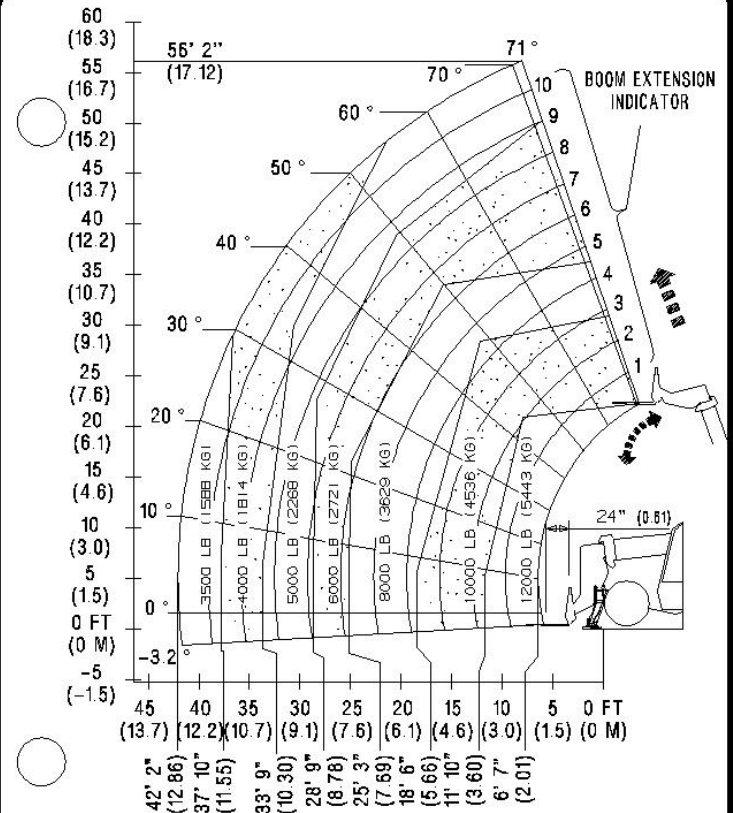

NO TIRE BALLAST
72" SIDE TILT CARRIAGE
72" PALLET FORKS

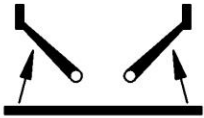

JCB 514 56
NORTH AMERICA

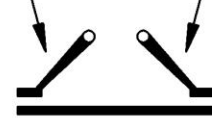
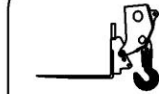
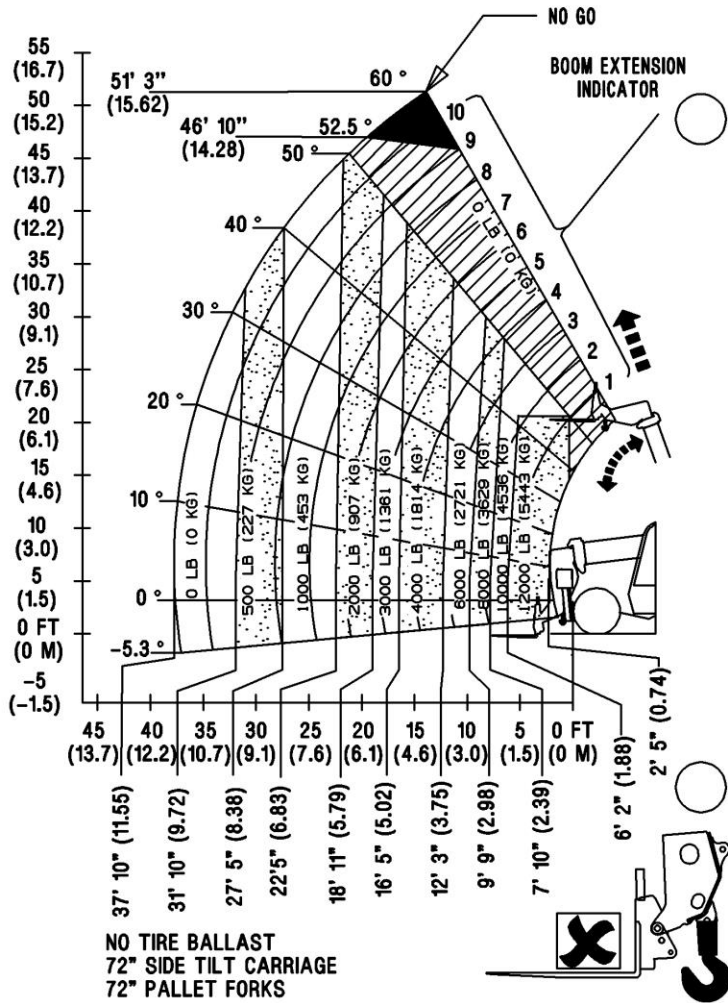

JCB 514 56
NORTH AMERICA

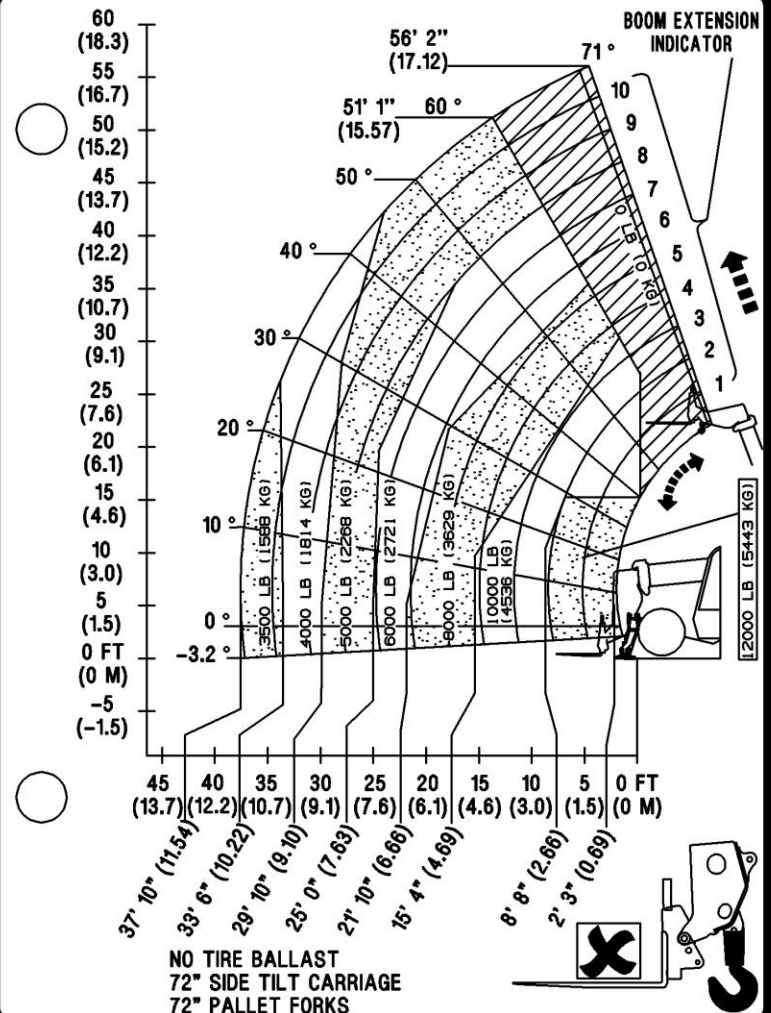



JCB 514 56

NORTH AMERICA

STAR INDUSTRIES EXTENDABLE BOOM MODEL 1360B

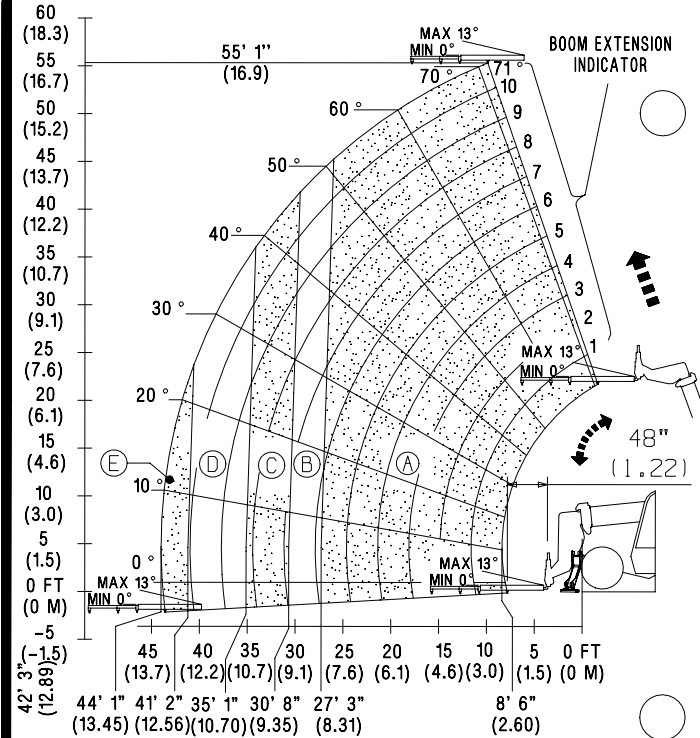
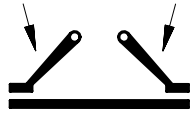

POSITION	1	2	3	4
A	5000 LB	3000 LB		
B	4000 LB		2000 LB	1750 LB
C	3000 LB	2500 LB		
D	2000 LB	1750 LB	1750 LB	1500 LB
E	1500 LB	1500 LB	1250 LB	1250 LB

NO TIRE BALLAST
72" STANDARD CARRIAGE
48" AND 60" PALLET FORKS



JCB 514 56

NORTH AMERICA

STAR INDUSTRIES EXTENDABLE BOOM MODEL 1360B

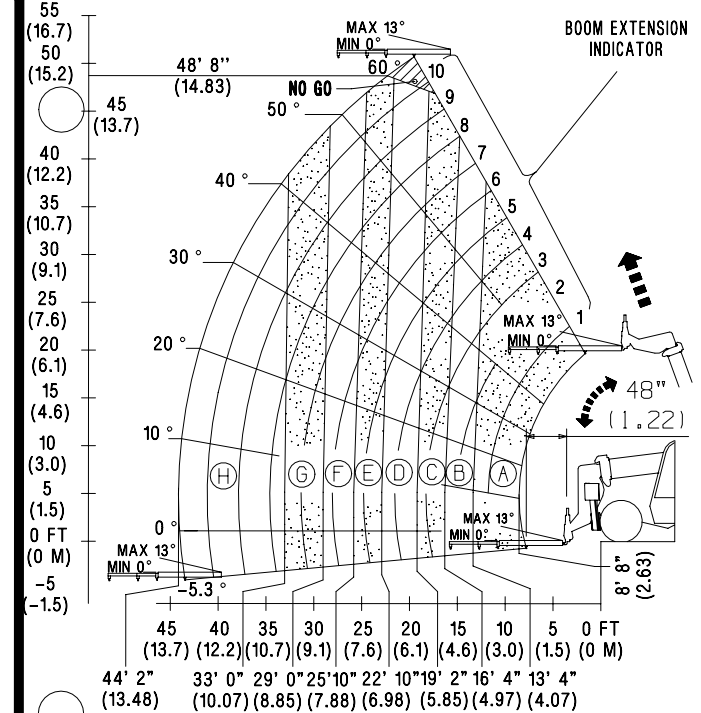
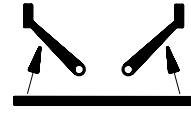

POSITION	1	2	3	4
A	5000 LB			
B	4000 LB	3000 LB	2000 LB	1750 LB
C	3000 LB	2500 LB		
D	2000 LB	1750 LB	1500 LB	1500 LB
E	1500 LB	1250 LB	1250 LB	1000 LB
F	1000 LB	750 LB	750 LB	750 LB
G	500 LB	250 LB	250 LB	250 LB
H	DO NOT USE			

NO TIRE BALLAST
72" STANDARD CARRIAGE
48" AND 60" PALLET FORKS

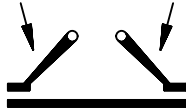

JCB 514 56
NORTH AMERICA

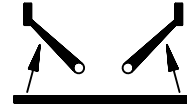
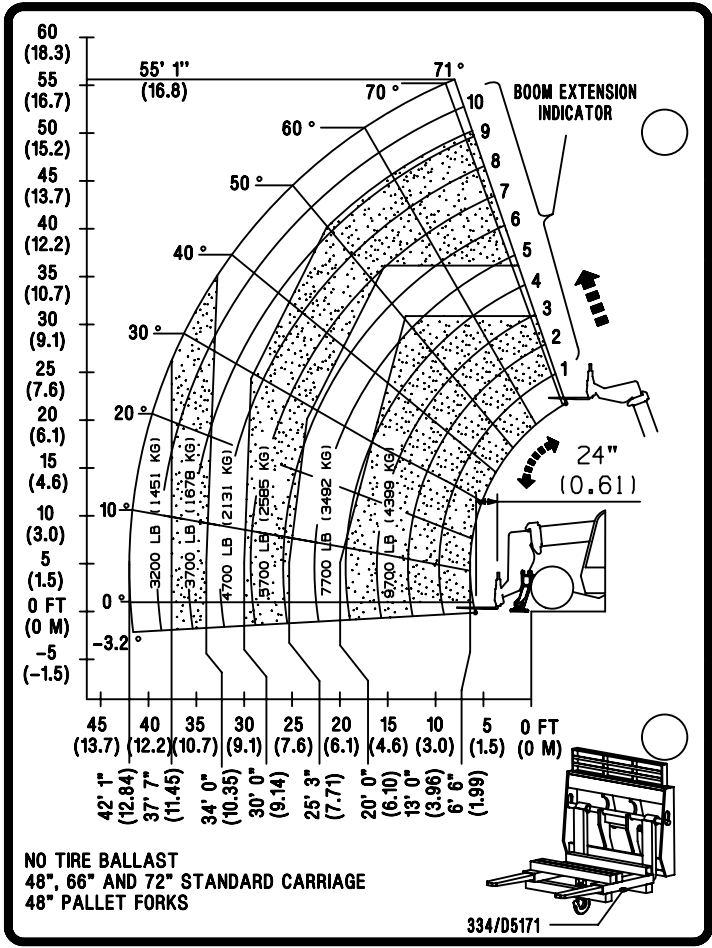

JCB 514 56
NORTH AMERICA

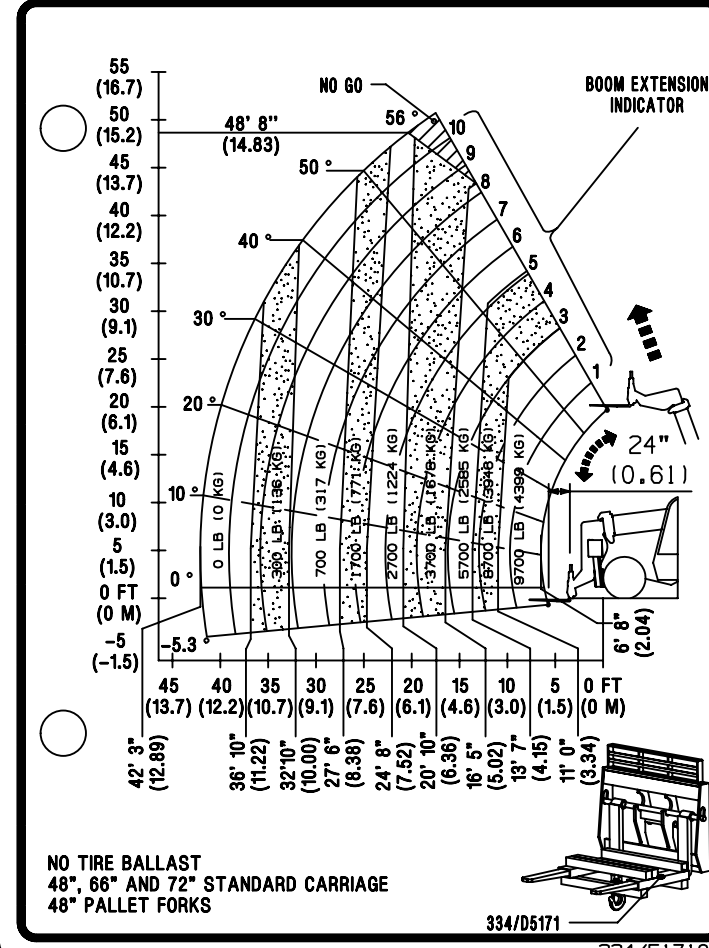

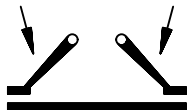

JCB 514 56
NORTH AMERICA

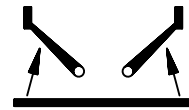
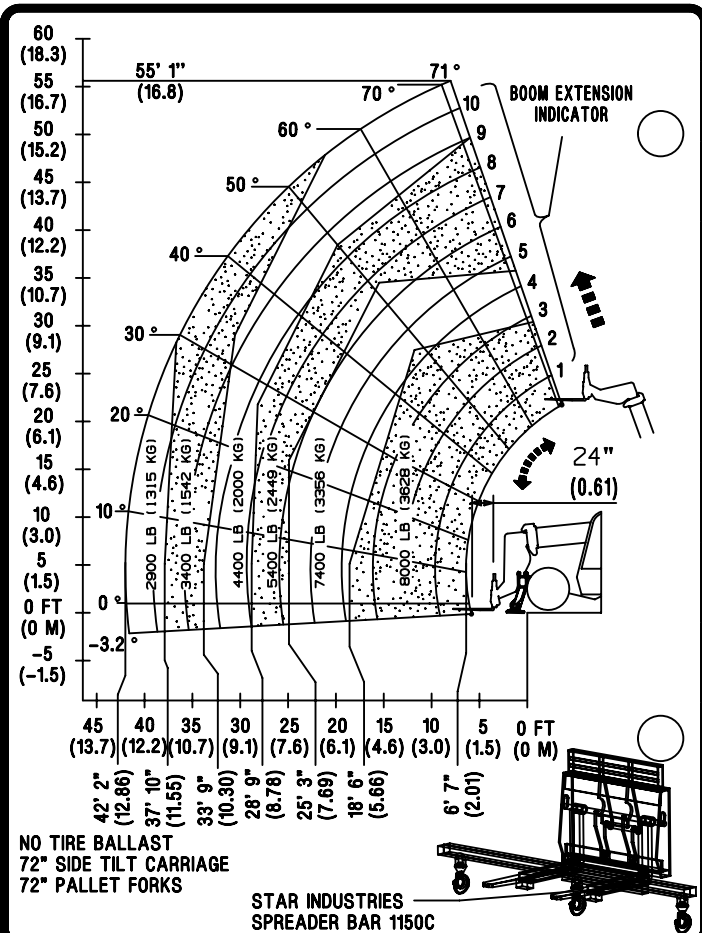

JCB 514 56
NORTH AMERICA

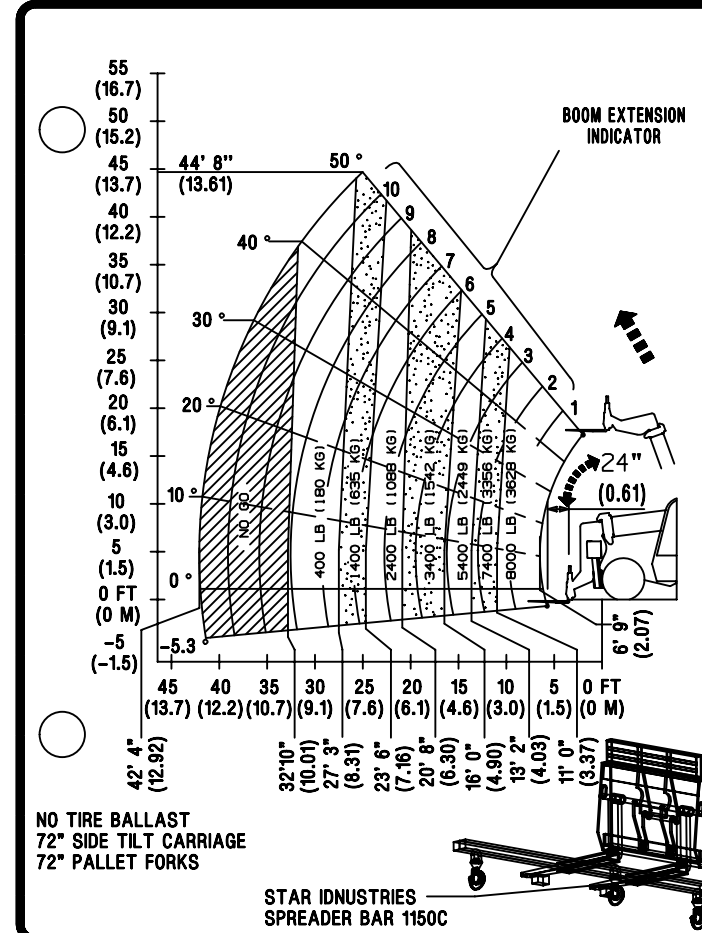

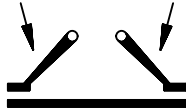

JCB 514 56
NORTH AMERICA

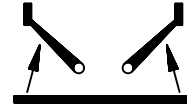
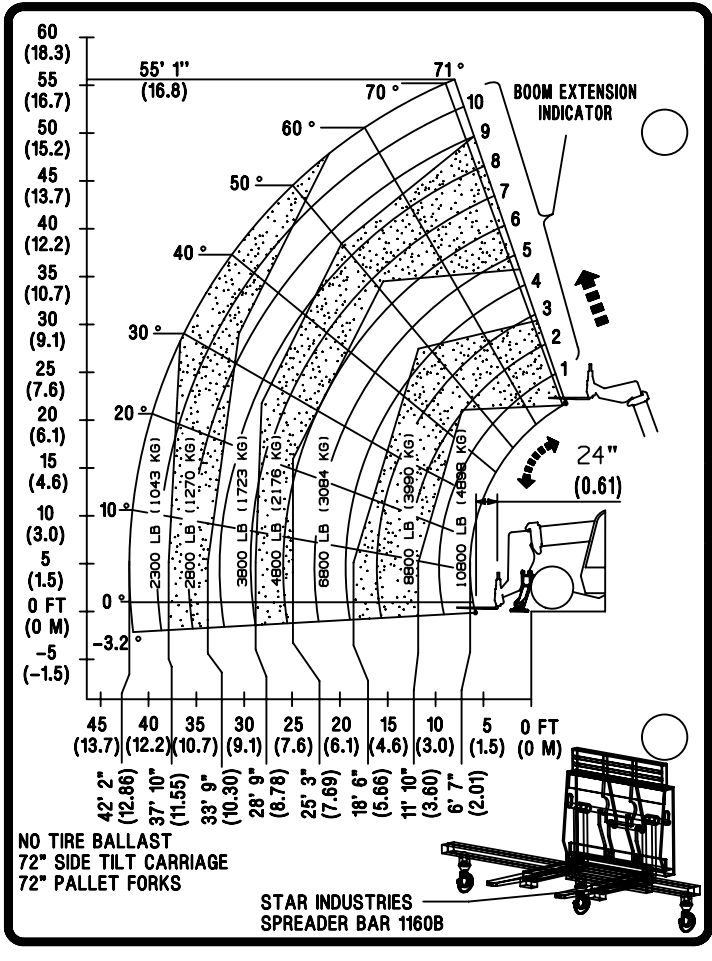

JCB 514 56
NORTH AMERICA

